

# Service Manual

DV4003 /K1SG/N1SG  
/N1B/U1B  
DVD Player

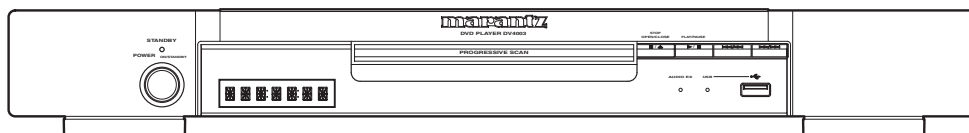

## TABLE OF CONTENTS

SECTION	PAGE
1. TECHNICAL SPECIFICATIONS .....	1
2. SERVICE HINTS AND TOOLS .....	6
3. WARNING AND LASER SAFETY INSTRUCTIONS .....	7
4. TAKING THE DISC OUT OF EMERGENCY.....	8
5. UPDATE BACK END FIRMWARE PROCEDURE .....	9
6. SERVICE MODE.....	10
7. DVD REGION CODE SETTING PROCEDURE .....	11
8. WIRING DIAGRAM .....	13
9. BLOCK DIAGRAM .....	15
10. SCHEMATIC DIAGRAM.....	17
11. PARTS LOCATION .....	33
12. EXPLODED VIEW AND PARTS LIST.....	47

Please use this service manual with referring to the user guide ( D.F.U. ) without fail.  
修理の際は、必ず取扱説明書を準備し操作方法を確認の上作業を行ってください。

# marantz®

## DV4003

## MARANTZ DESIGN AND SERVICE

Using superior design and selected high grade components, **MARANTZ** company has created the ultimate in stereo sound. Only original **MARANTZ** parts can insure that your **MARANTZ** product will continue to perform to the specifications for which it is famous.

Parts for your **MARANTZ** equipment are generally available to our National Marantz Subsidiary or Agent.

### ORDERING PARTS :

Parts can be ordered either by mail or by Fax.. In both cases, the correct part number has to be specified.

The following information must be supplied to eliminate delays in processing your order :

1. Complete address
2. Complete part numbers and quantities required
3. Description of parts
4. Model number for which part is required
5. Way of shipment
6. Signature : any order form or Fax. must be signed, otherwise such part order will be considered as null and void.

#### USA

**MARANTZ AMERICA, INC**  
100 CORPORATE DRIVE  
MAHWAH, NEW JERSEY 07430  
USA

#### EUROPE / TRADING

**D&M EUROPE B. V.**  
P. O. BOX 8744, BUILDING SILVERPOINT  
BEEMDSTRAAT 11, 5653 MA EINDHOVEN  
THE NETHERLANDS  
PHONE : +31 - 40 - 2507844  
FAX : +31 - 40 - 2507860

#### CANADA

**D&M Canada Inc.**  
5-505 APPLE CREEK BLVD.  
MARKHAM, ONTARIO L3R 5B1  
CANADA  
PHONE : 905 - 415 - 9292  
FAX : 905 - 475 - 4159

#### JAPAN

**D&M Holdings Inc.**  
D&M BUILDING, 2-1 NISSHIN-CHO,  
KAWASAKI-KU, KAWASAKI-SHI,  
KANAGAWA, 210-8569 JAPAN

株式会社 ディーアンドエムホールディングス  
本社 〒210-8569  
神奈川県川崎市川崎区日進町2-1 D&Mビル



#### KOREA

**D&M SALES AND MARKETING KOREA LTD.**  
CHUNG JIN B/D., #1001,  
53-5, WONHYORO 3 GA, YONGSAN-GU,  
SEOUL, 140-719, KOREA  
PHONE : +82 - 2 - 323 - 2155  
FAX : +82 - 2 - 323 - 2154

#### CHINA

**D&M SALES AND MARKETING SHANGHAI LTD.**  
ROOM.808 SHANGHAI AIRPORT CITY TERMINAL  
NO.1600 NANJING (WEST) ROAD, SHANGHAI,  
CHINA. 200040  
TEL : 021 - 6248 - 5151  
FAX : 021 - 6248 - 4434

### NOTE ON SAFETY :

Symbol  Fire or electrical shock hazard. Only original parts should be used to replaced any part marked with symbol  . Any other component substitution (other than original type), may increase risk of fire or electrical shock hazard.

### 安全上の注意 :

 がついている部品は、安全上重要な部品です。必ず指定されている部品番号のものを使用して下さい。

### SHOCK, FIRE HAZARD SERVICE TEST :

**CAUTION :** After servicing this appliance and prior to returning to customer, measure the resistance between either primary AC cord connector pins ( with unit NOT connected to AC mains and its Power switch ON ), and the face or Front Panel of product and controls and chassis bottom.

Any resistance measurement less than 1 Megohms should cause unit to be repaired or corrected before AC power is applied, and verified before it is return to the user/customer.

Ref. UL Standard No. 60065.

In case of difficulties, do not hesitate to contact the Technical Department at above mentioned address.

# 1. TECHNICAL SPECIFICATIONS

## General

System..... DVD-Video, DVD±R/RW, Video CD, CD, MP3 files, JPEG files, DviX, WMA and USB

Power requirements

    K version ..... AC 220 V 50 Hz

    N Version ..... AC 230 V, 50 Hz

    U Version ..... AC 120 V, 60 Hz

Power consumption ..... 16 W

Power consumption in standby mode ..... Less than 1 W

Weight ..... 2.9 kg (6 lb 39 oz)

Dimensions..... 440 (W) x 59 (H) x 318 (D) mm  
 (17 3/8 (W) x 2 3/8 (H) x 12 9/16 (D) in)

Operating temperature ..... + 5 °C to + 35 °C  
 (+ 41 °F to + 96 °F)

Operating humidity ..... 5 % to 85 % (no condensation)

## S-Video output

Y (luminance) - Output level ..... 1 Vp-p (75 Ω)

C (color) - Output level..... 286 mVp-p (75 Ω)

Jacks ..... S-VIDEO jack

## Video output

Output level..... 1 Vp-p (75 Ω)

Jacks ..... RCA jack

## Component video output (Y, Cb, Cr)

Output level..... Y : 1.0 Vp-p (75 Ω)  
 Cb/Pb, Cr/Pr : 0.7 Vp-p (75 Ω)

Jacks ..... RCA jack

## HDMI output

Version..... 1.0.

Output Terminal ..... 19-pin

## 21-pin connector assignment [/N : Europe model only]

AV connector output ..... 21-pin connector

This connector provides the video and audio signals for connection to a compatible color TV or monitor.

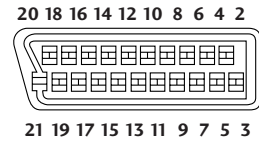

PIN no.		
1	Audio 2/R out	15 R out
3	Audio 1/L out	16 Blank
4	GND	17 GND
7	B out	19 Video out
8	Status	21 GND
11	G out	

## Audio output [/N/U only]

Output level (During audio output)..... 2 Vrms (1 kHz, 0 dB)

Number of channels ..... 2

Jacks ..... RCA jack

## Audio characteristics [/N/U only]

Frequency response ..... 4 Hz to 44 kHz (DVD fs: 96 kHz)

S/N ratio..... 110 dB

Dynamic range ..... 100 dB

Total harmonic distortion ..... 0.003 %

Wow and flutter : Limit of measurement  
 ..... (± 0.001 % W. PEAK) or lower

## Digital output

Coaxial digital output ..... RCA jack

## Other terminals

Control in/out [/U : USA only]..... RCA jack

USB input (USB 2.0)..... 1

## Accessories

Remote control (RC001DV)..... 1

AAA/R03 dry cell batteries ..... 2

Audio/Video cable (yellow/red/white)..... 1

Power cable ..... 1

User Guide ..... 1

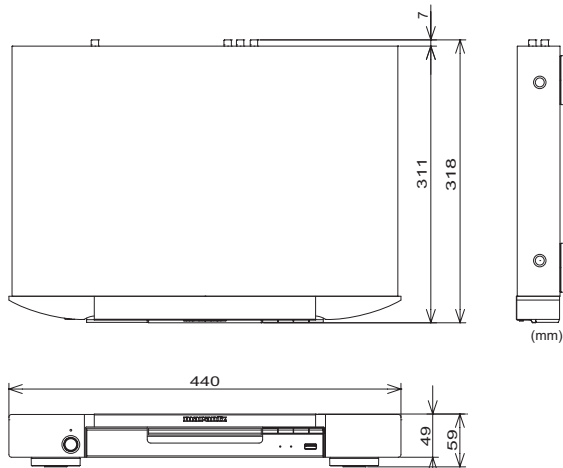

## 附加信息

### 规格

**一般系统**

DVD-Video、DVD±R/RW、VCD、CD、MP3 文件、JPEG 文件、DivX、WMA 和 USB  
 电源要求 ..... 220 V, 50Hz  
 功率消耗 ..... 16 W  
 待机模式下的功率消耗 ..... <1 W  
 重量 ..... 2.9 kg  
 外形尺寸 ..... 440(宽)×59(高)×318(深)mm  
 工作温度 ..... +5°C至 +35°C  
 工作湿度 ..... 5% 至 85% (无结露)

**S 视频输出端**

Y (亮度) 一输出电平 ..... 1 V<sub>p-p</sub> (75Ω)  
 C (色彩) 一输出电平 ..... 286 mV<sub>p-p</sub> (75Ω)  
 插孔 ..... S-VIDEO (S 视频) 插孔

**视频输出端**

输出电平 ..... 1 V<sub>p-p</sub> (75Ω)  
 插孔 ..... RCA 插孔

**分量视频输出 (Y, C<sub>B</sub>, C<sub>R</sub>)**

输出电平 ..... Y:1.0 V<sub>p-p</sub> (75 Ω)  
 ..... C<sub>B</sub>/P<sub>B</sub>, C<sub>R</sub>/P<sub>R</sub>:0.7 V<sub>p-p</sub> (75 Ω)  
 插孔 ..... RCA 插孔

**HDMI 输出端**

输出端子 ..... 19 针

**音频输出端**

输出电平  
 音频输出期间 ..... 2±0.3 V<sub>rms</sub> (1kHz, 0 dB)  
 声道数 ..... 2  
 插孔 ..... RCA 插孔

**音频特征**

频率响应 .. 17 Hz 至 22 kHz (DVD fs:96 kHz)  
 信噪比 ..... ≥90 dB  
 动态范围 ..... ≥90 dB  
 总谐波失真 ..... 0.003 %  
 抖晃率: 测量限制 (±0.001% W. PEAK) 或更低

**数字输出端**

同轴数字输出端 ..... RCA 插孔

**其它端子**

USB 输入 (USB 2.0) ..... 1

**附件**

遥控器 ..... 1  
 AAA/R03 干电池 ..... 2  
 音频/视频电缆 (黄色/红色/白色) ..... 1  
 电源线 ..... 1  
 使用说明书 (本说明书)

*注: 因产品改进, 规格和设计若有变更, 恕不另行通知。*

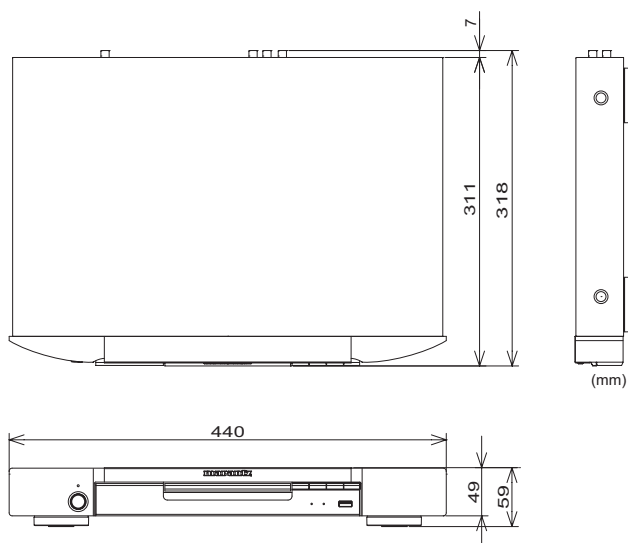



## Features

### USB Operation

You can play or view the data files (JPEG, MP3, WMA, or DivX<sup>®</sup>) in the USB flash drive.

### CD Ripping

This feature allows you to convert audio tracks from an audio CD into MP3 format. The created MP3 files are saved in your USB device.

### An HDCP-compatible HDMI\*<sup>1</sup> terminal is provided to ensure the very highest picture and digital sound quality by fully digital transmission.

This unit is equipped with an HDCP-compatible digital image output terminal (HDMI) to provide copyright protection.

Direct digital transmission without analog conversion of DVD image data makes it possible to enjoy real-life images without any image deterioration resulting from AD/DA conversion. The unit has also been designed to make it possible to handle the transmission of both digital video and digital audio with a single connector.

### High quality 12-bit/108 MHz video D/A converter

The unit uses a video D/A converter that performs D/A conversion of all video signals in 12 bits and can perform 4x oversampling to let you enjoy beautiful video possible with DVD.

### High quality 24-bit/192 kHz DAC

The high specification 24-bit/192 kHz DAC delivers dynamic, smooth and expansive analog sound from CDs and DVDs.

DivX   \*<sup>2</sup>

You can enjoy DivX<sup>®</sup> files which are recorded on DVD±R/RW or CD-R/RW.

- Official DivX<sup>®</sup> Ultra Certified product
- Plays all versions of DivX<sup>®</sup> video (including DivX<sup>®</sup> 6) with enhanced playback of DivX<sup>®</sup> media files and the DivX<sup>®</sup> Media Format
- This player supports Quarter Pixel.
- This player does not support GMC.

### MP3 and WMA\*<sup>3</sup> compatibility

This player is compatible with CD-R, CD-RW and CD-ROM discs that contain MP3 and WMA audio tracks (see pages 27, 29).

### JPEG compatibility

This player is compatible with CD-R, CD-RW and CD-ROM discs that contain JPEG data (see pages 27, 28, 29).

\*<sup>1</sup> HDMI, the HDMI logo and High-Definition Multimedia Interface are trademarks or registered trademarks of HDMI Licensing LLC.

\*<sup>2</sup> "DivX", and "DivX Ultra" Certified, and associated logos are trademarks of DivX, Inc. and are used under license.

\*<sup>3</sup> Windows Media and the Windows logo are trademarks, or registered trademarks of Microsoft Corporation in the United States and/or other countries.



Manufactured under license from Dolby Laboratories. "Dolby" and the double-D symbol are trademarks of Dolby Laboratories.



"DTS" and "DTS Digital Out" are registered trademarks of DTS, Inc.

## Discs compatible with this player

Any disc that displays one of the following logos should play in this player. Other formats, including DVD-RAM, DVD-ROM, CD-ROM (except those that contain MP3/DivX/WMA/JPEG files) and Photo CD will not play.

### DVD-Video compatibility:

- Logos: 
- Single-sided or double-sided discs
- Single layer or dual layer discs
- Dolby Digital, DTS, MPEG or Linear PCM digital audio
- MPEG-2 digital video

Discs are generally divided into one or more titles. Titles may be further subdivided into chapters.

### DVD-R compatibility:

This unit can play DVD-R discs. Please note the following points when using these discs:

- Logo: 
- This unit can play DVD-R discs recorded as DVD-Video format.

### DVD-RW compatibility:



This unit can play DVD-RW discs. Please note the following points when using these discs:

- Logo: 
- This unit can play DVD-RW discs recorded as DVD-Video format, and DVD-VR format.
- DVD-RW discs that were recorded with copy-once only permission can be played.

### DVD+R/+RW compatibility:

- Logo:  
- This unit can play DVD+R/+RW discs. Please note the followings points when using these discs.

### Audio CD compatibility:

- Logos:   
- 12cm (5in.) or 8cm (3in.) discs
- Linear PCM digital audio
- Audio CD, CD-R\* and CD-RW\* formats

\*This unit can play CD-R and CD-RW discs recorded in Audio CD or Video CD format, or with MP3 audio files or Windows Media audio files or picture files or DivX files.

\*Some copy-controlled CDs may not conform to official CD standards. They are special discs and may not play on the DV4003.

\*The DV4003 does not support the non-DVD side of a Dual Disc.

### Video CD compatibility:

- Logo: 
- 12cm (5in.) or 8cm (3in.) discs
- MPEG-1 digital audio
- MPEG-1 digital video

Video CDs are divided into tracks.

### Super VCD compatibility:

- Logo: 
- 12cm (5in.) or 8cm (3in.) discs
- MPEG-1 digital audio
- MPEG-2 digital video

Super VCDs are divided into tracks.

## DVD-Video regions

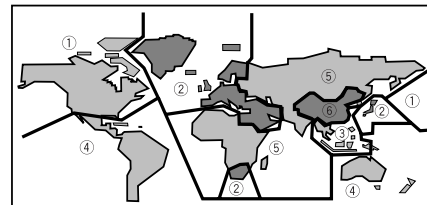

All DVD-Video discs carry a region mark on the case somewhere that indicates which region(s) of the world the disc is compatible with. Your DVD player also has a region mark, which you can find on the rear panel. Discs from incompatible regions will not play in this player. Discs marked ALL will play in any player.

## General information for MP3/WMA/JPEG/DivX

- This player can recognize in total about 650 files per folders and 300 folder per disc for MP3/DivX/WMA.
- When writing MP3/WMA/JPEG/DivX files to CD-R/RW discs, always be sure to set the writing format to ISO 9660 Level 1.
- For MP3 and WMA files recorded in Variable Bit Rate (VBR), the unit may not display the actual elapsed time.
- For, MP3 and WMA, this player is not compatible with multi-session discs. If you try and play a multi-session disc, only the first session will be played.

## MP3 compatibility information

- Files should be MPEG1 Audio Layer 3 format. The sampling rate is 11 kHz to 48 kHz, but it is depends on the bit rate. Incompatible files will not play.
- Audio encoded at 128 kbps should sound close to regular audio CD quality. Although this player will play 32 kbps to 320 kbps, but it is depends on the sampling rate.
- This player is compatible with ID3 ver.1.1 Tag.
- Maximum 30 characters can be displayed on TV screen.
- This player cannot play DVD-R/RW discs with recorded MP3 music data.
- This player only plays tracks that are named containing the file extension “.mp3” or “.MP3”.

## WMA compatibility information

- The sampling rate is 44.1 kHz (bit rate: 64 kbps-192 kbps) and 48 kHz (bit rate: 128 kbps-192 kbps).
- This player only plays tracks that are named with the file extension “.wma” or “.WMA”.
- This player can not play the disc contents protected by Windows Media Digital Right Management (DRM).

## JPEG compatibility information

- While this player is designed to be able to handle image data recorded in JPEG format, no assurances are given that the player will be able to display image data recorded in all JPEG formats.
- This player can display progressive JPEG images.
- This player can display HD JPEG images.

- Always be sure to specify a file extension of “.JPG” or “.JPEG” for JPEG files. The file will not be able to be displayed if a file extension other than “.JPG” or “.JPEG” is specified or if no file extension is assigned to the file. (Note that this means that JPEG files created on a Macintosh will not be able to be displayed as is.)
- Depending on the file size and compression ratio, some JPEG pictures cannot be displayed correctly.

Maximum supported JPEG resolution are shown below:

- For baseline JPEG, the supported maximum resolution is 3072 x 2048
- For progressive JPEG, the supported maximum resolution is as shown:  
Width x (Height + 128) < 3300000

## DivX compatibility information

- A file with an extension of “.avi” or “.divx” is called a DivX file.
- Maximum 30 characters can be displayed on TV screen.
- File should be MPEG1 Audio Layer 3 format and MPEG2 format.
- Support for DivX 3.11, 4.x, 5.x, 6.x and Ultra.
- Q-pel accurate motion compensation.
- Global Motion Compensation (GMC) Playback.

## Caution!

- DVD±R/RW and CD-R/RW discs recorded using a personal computer or a DVD or CD recorder may not play if the disc is damaged or dirty, or if there is dirt or condensation on the player's lens.
- If you record a disc using a personal computer, even if it is recorded in a compatible format, there are cases in which it may not play because of the settings of the application software used to create the disc. (Check with the software publisher for more detailed information.)
- There may be times when it is impossible to replay a CD-R/RW disc because of the characteristics of the disc being used or because of dirt or scratches on the disc.
- Unfinalized DVD-R/RW discs cannot be played.
- Unfinalized CD-R/RW discs cannot be played.
- For more information on using DVD-R/RW and CD-R/RW discs, see “Handling discs” on **page 48**.
- Never try to replay anything other than a music CD (CDA format) or a CD-R/RW on which MP3 and/or JPEG files have been stored. Depending on the type of file, there may be times when doing so will result in problems or erroneous operation.

## 2. SERVICE HINTS AND TOOLS

### SERVICE HINTS

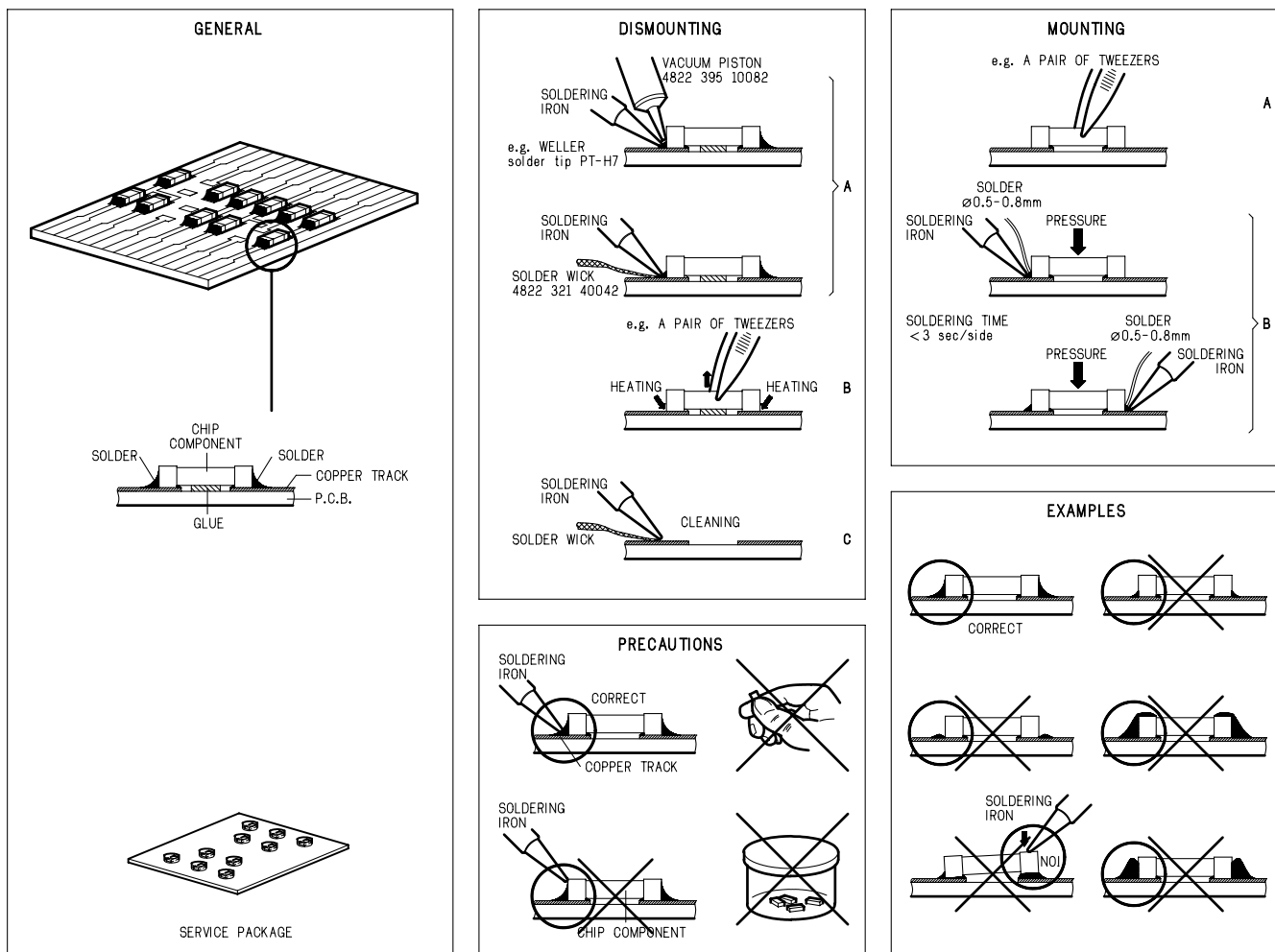

### SERVICE TOOLS

Audio signals disc	4822 397 30184 or TCD-784
Disc without errors +	
Disc with DO errors, black spots and fingerprints	4822 397 30245 (SBC444A) or TCD-726
Disc (65 min 1kHz) without no pause	4822 397 30155
Max. diameter disc (58.0 mm)	4822 397 60141
Torx screwdrivers	
Set (straight)	4822 395 50145
Set (square)	4822 395 50132
13th order filter	4822 395 30204
DVD test disc (PAL)	4822 397 10131
DVD test disc (NTSC) ALMEDIO	TDV-540

070703MZ

### 3. WARNING AND LASER SAFETY INSTRUCTIONS

**GB** WARNING

All ICs and many other semi-conductors are susceptible to electrostatic discharges (ESD). Careless handling during repair can reduce life drastically.

When repairing, make sure that you are connected with the same potential as the mass of the set via a wrist wrap with resistance.

Keep components and tools also at this potential.

**ESD**



**NL** WAARSCHUWING

Alle IC's en vele andere halfgeleiders zijn gevoelig voor elektrostatische ontladingen (ESD).

Onzorgvuldig behandelen tijdens reparatie kan de levensduur drastisch doen verminderen.

Zorg ervoor dat u tijdens reparatie via een polsband met weerstand verbonden bent met hetzelfde potentiaal als de massa van het apparaat.

Houd componenten en hulpmiddelen ook op hetzelfde potentiaal.

**F** ATTENTION

Tous les IC et beaucoup d'autres semi-conducteurs sont sensibles aux décharges statiques (ESD).

Leur longévité pourrait être considérablement écourtée par le fait qu'aucune précaution n'est prise à leur manipulation.

Lors de réparations, s'assurer de bien être relié au même potentiel que la masse de l'appareil et enfiler le bracelet serti d'une résistance de sécurité.

Veiller à ce que les composants ainsi que les outils que l'on utilise soient également à ce potentiel.

**D** WARNUNG

Alle IC und viele andere Halbleiter sind empfindlich gegen elektrostatische Entladungen (ESD).

Unvorsichtige Behandlung bei der Reparatur kann die Lebensdauer drastisch vermindern. Sorgen sie dafür, das Sie im Reparaturfall über ein Pulsarmband mit Widerstand mit dem Massepotential des Gerätes verbunden sind.

Halten Sie Bauteile und Hilfsmittel ebenfalls auf diesem Potential.

**I** AVVERTIMENTO

Tutti IC e parecchi semi-conduttori sono sensibili alle scariche statiche (ESD).

La loro longevita potrebbe essere fortemente ridatta in caso di non osservazione della piu grande cauzione alla loro manipolazione.

Durante le riparazioni occorre quindi essere collegato allo stesso potenziale che quello della massa dell'apparecchio tramite un braccialetto a resistenza.

Assicurarsi che i componenti e anche gli utensili con quali si lavora siano anche a questo potenziale.

**GB**

Safety regulations require that the set be restored to its original condition and that parts which are identical with those specified be used.

**NL**

Veiligheidsbepalingen vereisen, dat het apparaat in zijn oorspronkelijke toestand wordt terug gebracht en dat onderdelen, identiek aan de gespecificeerde worden toegepast.

**D**

Bei jeder Reparatur sind die geltenden Sicherheitsvorschriften zu beachten. Der Originalzustand des Gerats darf nicht verändert werden. Für Reparaturen sind Original-Ersatzteile zu verwenden.

**I**

Le norme di sicurezza esigono che l'apparecchio venga rimesso nelle condizioni originali e che siano utilizzati pezzi di ricambio idetici a quelli specificati.

"Pour votre sécurité, ces documents doivent être utilisés par des spécialistes agréés, seuls habilités à réparer votre appareil en panne."

**F**

Les normes de sécurité exigent que l'appareil soit remis a l'état d'origine et que soient utilisées les pièces de rechange identiques à celles spécifiées.

### LASER SAFETY

This unit employs a laser. Only a qualified service person should remove the cover or attempt to service this device, due to possible eye injury.



**USE OF CONTROLS OR ADJUSTMENTS OR PERFORMANCE OF PROCEDURE OTHER THAN THOSE SPECIFIED HEREIN MAY RESULT IN HAZARDOUS RADIATION EXPOSURE.**

**AVOID DIRECT EXPOSURE TO BEAM**

#### WARNING

**The use of optical instruments with this product will increase eye hazard. Repair handling should take place as much as possible with a disc loaded inside the player**

#### WARNING LOCATION: INSIDE ON LASER COVERSIELD

**CAUTION** VISIBLE AND INVISIBLE LASER RADIATION WHEN OPEN AVOID EXPOSURE TO BEAM  
**ADVARSEL** SYNLIG OG USYNLIG LASERSTRÅLING VED ÅBNING UNDGÅ UDSÆTTELSE FOR STRÅLING  
**ADVARSEL** SYNLIG OG USYNLIG LASERSTRÅLING NÅR DEKSEL Å PNES UNNGÅ EKSPONERING FOR STRÅLEN  
**VARNING** SYNLIG OCH OSYNLIG LASERSTRÅLNING NÅR DENNA DEL ÅR ÖPPNAD BETRAKTA EJ STRÅLEN  
**VARO!** AVATT AESSA OLET ALTTIINA NÄKYVÄLLE JA NÄKYMÄTTÖMÄLLE LASER SÄTEILYLLE. ÄLÄ KATSO SÄTEESEEN  
**VORSICHT** SICHTBARE UND UNSICHTBARE LASERSTRAHLUNG WENN ABDECKUNG GEÖFFNET NICHT DEM STRAHL AUSSETSEN  
**DANGER** VISIBLE AND INVISIBLE LASER RADIATION WHEN OPEN AVOID DIRECT EXPOSURE TO BEAM  
**ATTENTION** RAYONNEMENT LASER VISIBLE ET INVISIBLE EN CAS D'OUVERTURE EXPOSITION DANGEREUSE AU FAISCEAU

#### 4. TAKING THE DISC OUT OF EMERGENCY

1. Remove the top cover of the player.
2. Remove 2 screws shown in the picture follows.
3. Remove the disc clamber.
4. Now you can remove the disc.

Remove those screws



## 5. UPDATES BACK END FIRMWARE PROCEDURE

### Necessary Equipment

- Update data (dv4003m1.bin or dv4003m2)
- USB flash drive

**NOTICE :** The dv4003m1.bin is update data for /N1B, /N1SG and /U1B. The dv4003m2.bin is update date for /K1SG.

### Writing Procedure

The writing of firmware takes about 1 minute 15 seconds.

1. Put the update data to the USB flash drive.

**REMARK :** Please DO NOT put two update data to USB flash drive. When update /N1B, /N1SG or /U1B, please put only dv4003m1.bin. When update /K1SG, please put only dv4003m2.bin.

2. Connect the video cable to the unit and TV (or Monitor).
3. Connect the mains cord into the unit.
4. Turn on the unit and TV.
5. Insert the USB flash drive to USB port of the unit.
6. "Press DISC SKIP key to switch device" is displayed on the TV.
7. Press the **DISC SKIP** button of the remote controller.
8. Firmware is written into the flash ROM.

**REMARK :** Please DO NOT remove the USB flash drive, and DO NOT turn off the unit. Because the flash ROM of the unit is damaged and can never write in firmware.

9. "UPGRADE FILE DETECTED" and "UPGRADING" are displayed on the TV.
10. FL display change from "ERASE" and displays "WRITE".
11. After that "UPG END" is displayed several seconds, and finished write-in.
12. The unit is reset automatically.
13. Remove the USB flash drive from the unit.
14. Press the **OPEN/CLOSE** button of remote controller to open the tray.
15. Press the button of remote controller in order as follows.

VERS. COLOR	RC button sequence
/K1SG	<b>9, 9, 9, 9, AUDIO and 1</b>
/N1B, /N1SG	<b>9, 9, 9, 9, AUDIO and 1</b>
/U1B	<b>9, 9, 9, 9, AUDIO and 2</b>

16. The tray closes automatically, and turns off the unit automatically.
17. Disconnect the mains cord and video cable from the unit.

### Firmware Version and Region code Check

To check the version of the firmware and region code, see "Firmware (Back-end) version check" in "SERVICE MODE" section.



## 6. SERVICE MODE

Firmware (Back-end) version check

Connect the DVD player to TV and operate by using Remote controller RC001DV.

1. Press the **POWER** button to turn on the unit.
2. Press the **OPEN/CLOSE** button to open the disc tray.
3. Press the **DISP.** (  )Button of the Remote controller.
4. The following information is displayed on the TV screen. The firmware version is shown.  
(Ex. : SD10.1 V14 4003-37 1)



5. Turn off power to quit Service Mode.



## 7. DVD REGION CODE SETTING PROCEDURE

The region code of MPEG (SD10.1) PWB ASSY supplied as spare parts is an initial value. Please change the region code from initial value to your region code, when replaced the MPEG PWB ASSY (POS. NO.1003).

Connect the video cable to the unit and TV (or Monitor) and operate by using Remote controller RC001DV.

### For /N1B and /N1SG (DVD Region 2)

1. Turn on the unit and TV.
2. Press the **OPEN/CLOSE** button to open the tray.
3. Press **9**, **9**, **9**, **9**, **AUDIO** (  ) and **1** buttons on the remote controller in that order.
4. The tray will close automatically, and then the unit is set to STANDBY mode.

### For /U1B (DVD Region 1)

1. Turn on the unit and TV.
2. Press the **OPEN/CLOSE** button to open the tray.
3. Press **9**, **9**, **9**, **9**, **AUDIO** (  ) and **2** buttons on the remote controller in that order.
4. The tray will close automatically, and then the unit is set to STANDBY mode.

### For /K1SG (DVD Region 6)

1. Turn on the unit and TV.
2. Press the **OPEN/CLOSE** button to open the tray.
3. Press **9**, **9**, **9**, **9**, **AUDIO** (  ) and **1** buttons on the remote controller in that order.
4. The tray will close automatically, and then the unit is set to STANDBY mode.

### DVD Region code check procedure

#### SERVICE MODE :

- Press the **POWER** button to turn on the unit.
- Press the **OPEN/CLOSE** button to open the disc tray.
- Press the **DISP.** (  ) Button of the Remote controller.
- The DVD Region code is displayed on the TV screen.

REG 1: DV4003/U1B

REG 2: DV4003/N1B, DV4003/N1SG

REG 6: DV4003/K1SG

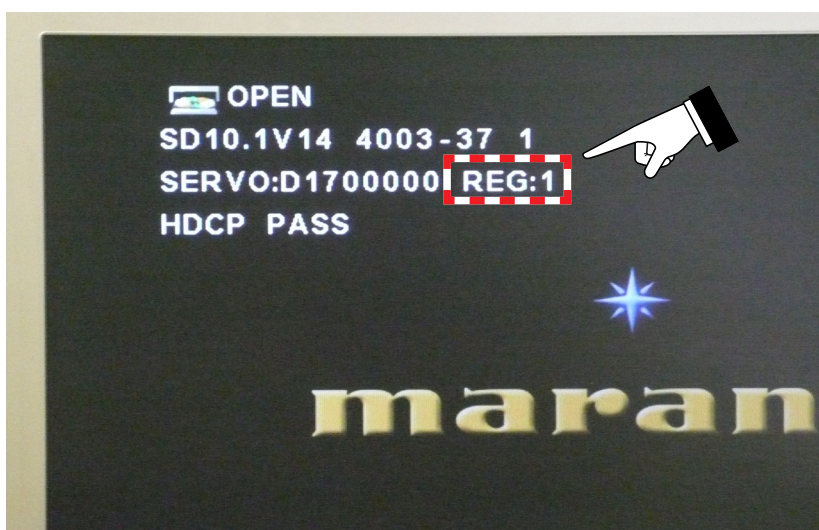



# 8. WIRING DIAGRAM

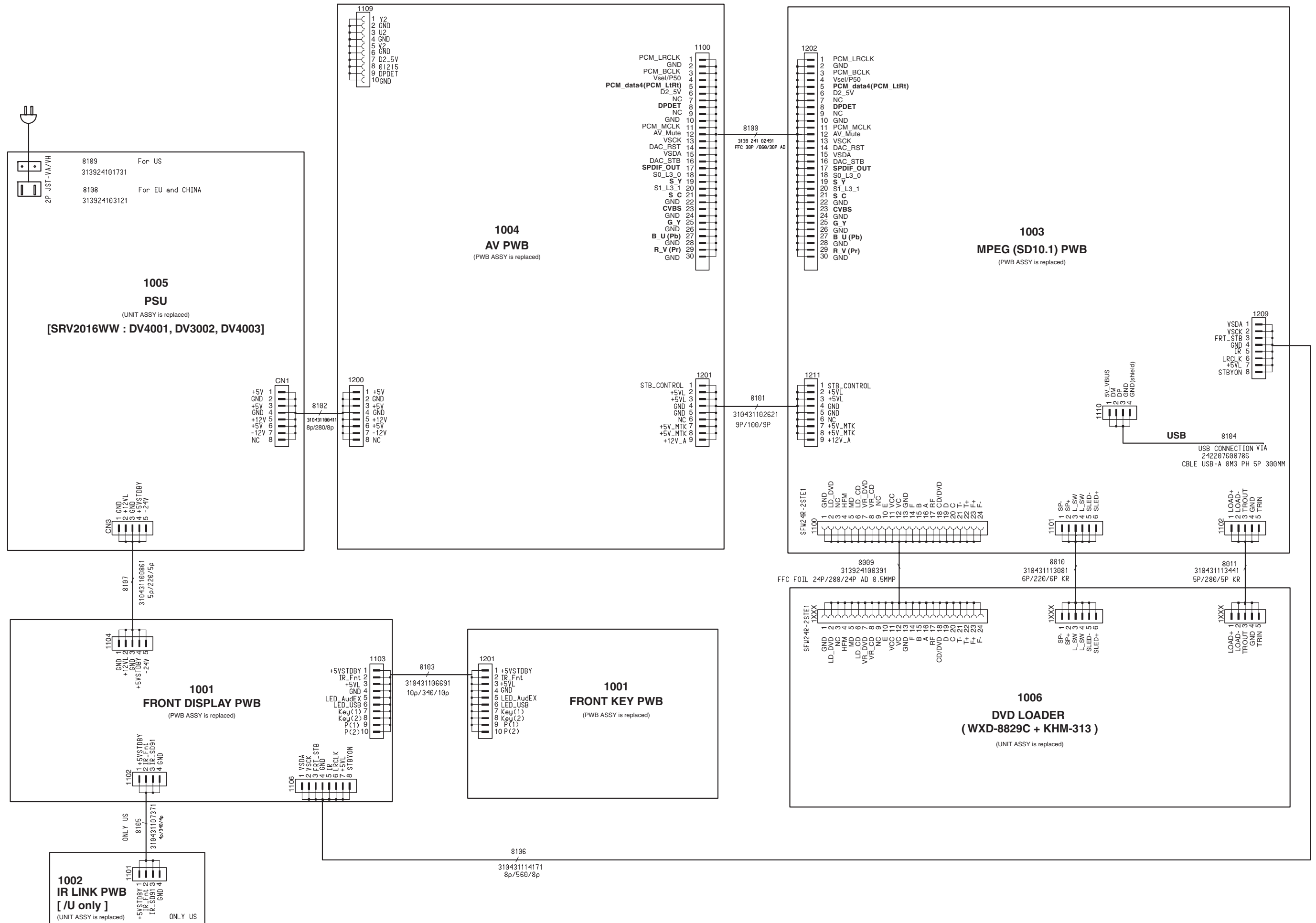

# 9. BLOCK DIAGRAM

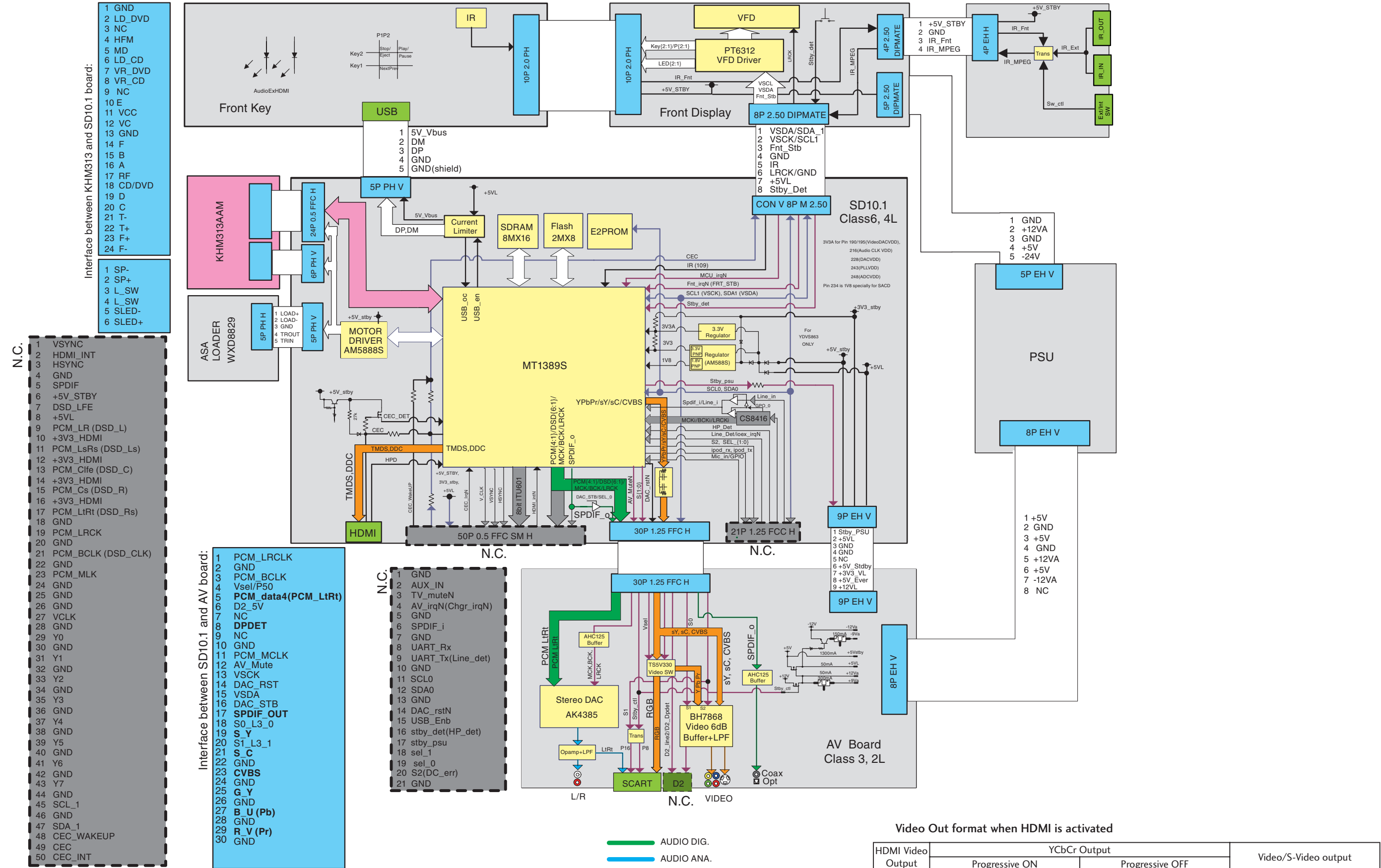

Video Out format when HDMI is activated

HDMI Video Output	YCbCr Output		Video/S-Video output
	Progressive ON	Progressive OFF	
480P	480P (NTSC progressive)		480i
576P	576P (PAL progressive)		576i
720P	480P or 576P		480i or 576i
1080i	Follow the Disc Source with Progressive output. (ex: NTSC disc is played: NTSC Progressive out.)		Follow the Disc Source with Interlace output. (ex: NTSC disc play: NTSC interlace)
1080P			

# 10. SCHEMATIC DIAGRAM

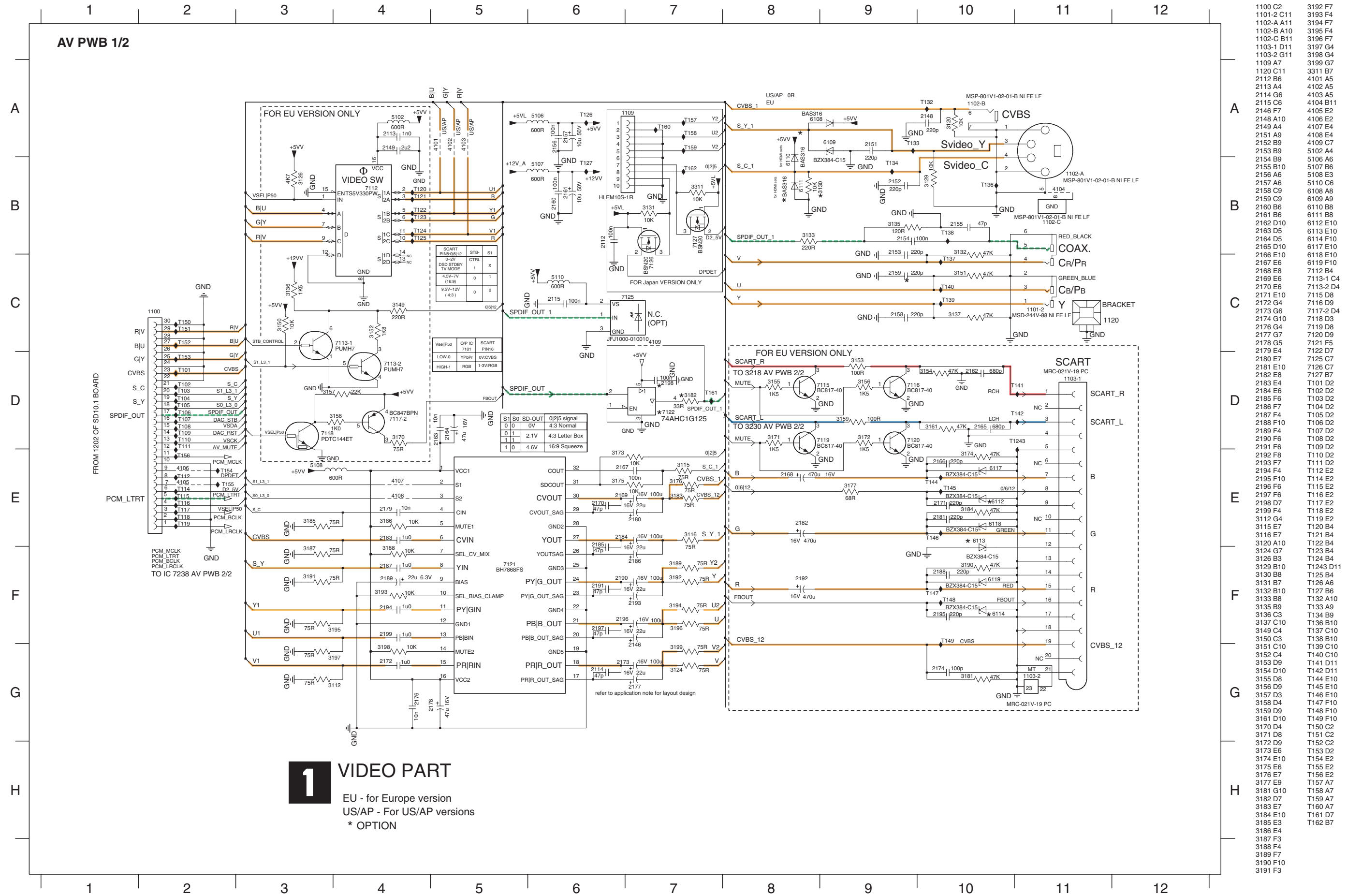



AV PWB 2/2



AUDIO & SUPPLY

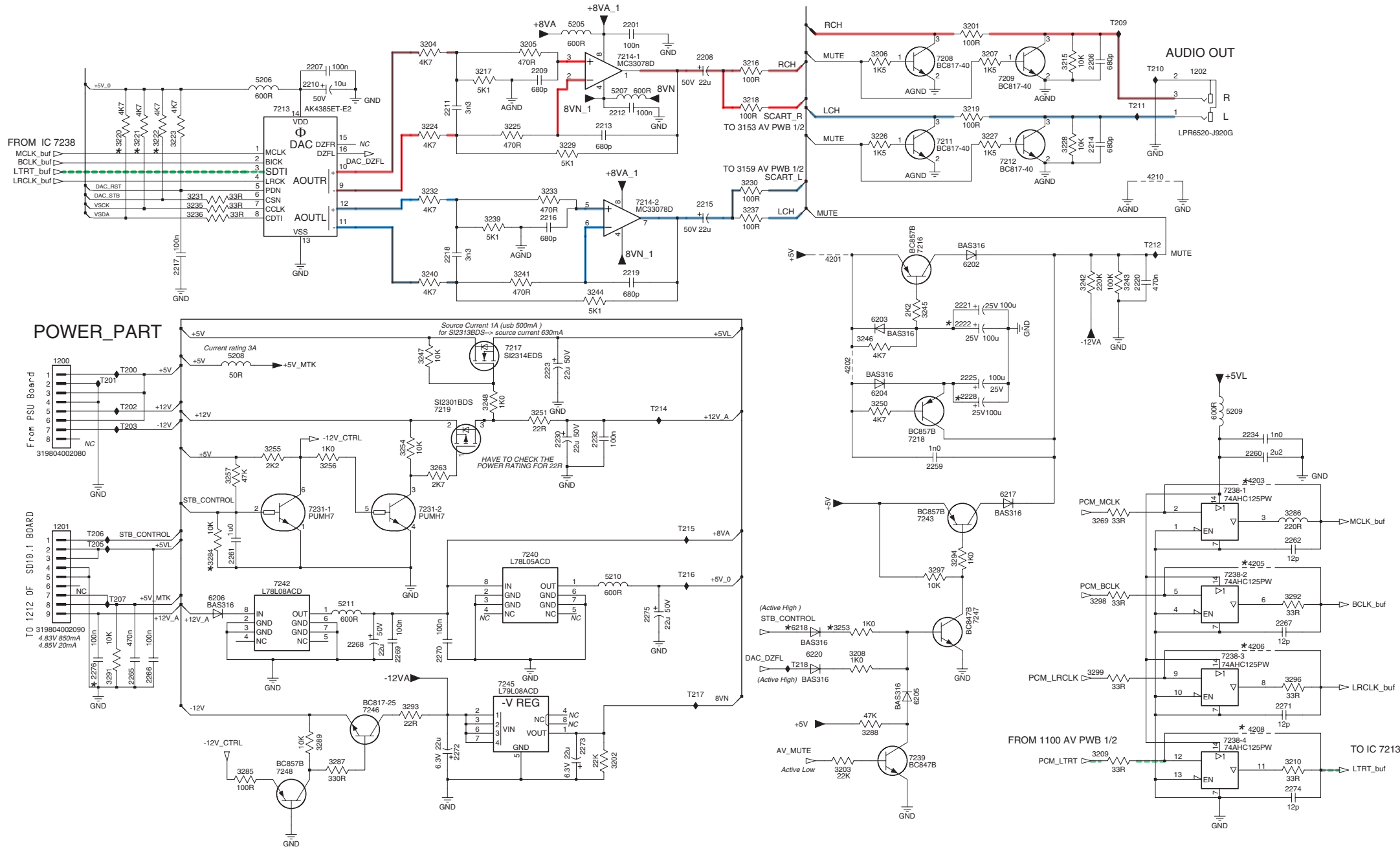

\* OPTION

- 1200 D2
- 1201 E2
- 1202 B11
- 2201 B6
- 2206 B10
- 2207 B4
- 2208 B7
- 2209 B6
- 2210 B4
- 2211 B5
- 2212 B6
- 2213 B6
- 2214 B10
- 2215 C7
- 2216 C6
- 2217 C3
- 2218 C5
- 2219 D6
- 2220 D10
- 2221 D9
- 2222 D9
- 2223 D6
- 2225 D9
- 2228 D9
- 2230 E6
- 2232 E6
- 2234 E11
- 2259 E9
- 2260 E11
- 2261 F3
- 2262 F12
- 2265 G3
- 2266 G3
- 2267 F12
- 2268 F4
- 2269 F5
- 2270 F5
- 2271 G12
- 2272 G5
- 2273 G6
- 2274 H12
- 2275 F7
- 2276 G2
- 3201 B9
- 3202 G6
- 3203 G8
- 3204 B5
- 3205 B6
- 3206 B8
- 3207 B9
- 3208 F8
- 3209 G10
- 3210 G12
- 3215 B10
- 3216 B7
- 3217 B5
- 3218 B7
- 3219 B9
- 3220 B2
- 3221 B3
- 3222 B3
- 3223 B3
- 3224 B5
- 3225 B6
- 3226 B8
- 3227 B9
- 3228 B10
- 3229 C6
- 3230 C7
- 3231 C3
- 3232 C5
- 3233 C6
- 3235 C3
- 3236 C3
- 3237 C7
- 3239 C5
- 3240 D5
- 3241 D6
- 3242 D10
- 3244 D6
- 3245 D9
- 3246 D8
- 3247 D5
- 3248 D5
- 3250 E8
- 3251 E6
- 3253 F8
- 3254 E5
- 3255 E4
- 3256 E4
- 3257 E3
- 3263 E5
- 3269 E10
- 3284 F3
- 3285 G3
- 3286 E12
- 3287 G4
- 3288 G8
- 3289 G4
- 3291 G2
- 3292 F12
- 3293 G5
- 3294 F9
- 3296 G12
- 3297 F9
- 3298 F10
- 3299 G10
- 4201 C8
- 4202 D8
- 4203 E11
- 4205 F11
- 4206 F11
- 4208 G11
- 4210 C11
- 5205 B6
- 5206 B4
- 5207 B6
- 5208 D3
- 5209 E11
- 5210 F6
- 5211 F4
- 5212 C9
- 5213 E6
- 5214 D8
- 5215 E9
- 5216 F3
- 5217 B9
- 5218 C9
- 5219 B4
- 5220 B9
- 5219 B9
- 5220 B9
- 5221 C6
- 5222 G5
- 5223 G9
- 5224 D5
- 5225 E9
- 5226 E4
- 5227 E5
- 5228 E4
- 5229 E5
- 5230 E5
- 5231 E5
- 5232 E5
- 5233 E5
- 5234 E5
- 5235 E5
- 5236 E5
- 5237 E5
- 5238 E5
- 5239 E5
- 5240 E5
- 5241 E5
- 5242 E5
- 5243 E5
- 5244 E5
- 5245 E5
- 5246 E5
- 5247 E5
- 5248 E5
- 5249 E5
- 5250 E5
- 5251 E5
- 5252 E5
- 5253 E5
- 5254 E5
- 5255 E5
- 5256 E5
- 5257 E5
- 5258 E5
- 5259 E5
- 5260 E5
- 5261 E5
- 5262 E5
- 5263 E5
- 5264 E5
- 5265 E5
- 5266 E5
- 5267 E5
- 5268 E5
- 5269 E5
- 5270 E5
- 5271 E5
- 5272 E5
- 5273 E5
- 5274 E5
- 5275 E5
- 5276 E5
- 5277 E5
- 5278 E5
- 5279 E5
- 5280 E5
- 5281 E5
- 5282 E5
- 5283 E5
- 5284 E5
- 5285 E5
- 5286 E5
- 5287 E5
- 5288 E5
- 5289 E5
- 5290 E5
- 5291 E5
- 5292 E5
- 5293 E5
- 5294 E5
- 5295 E5
- 5296 E5
- 5297 E5
- 5298 E5
- 5299 E5
- 5300 E5

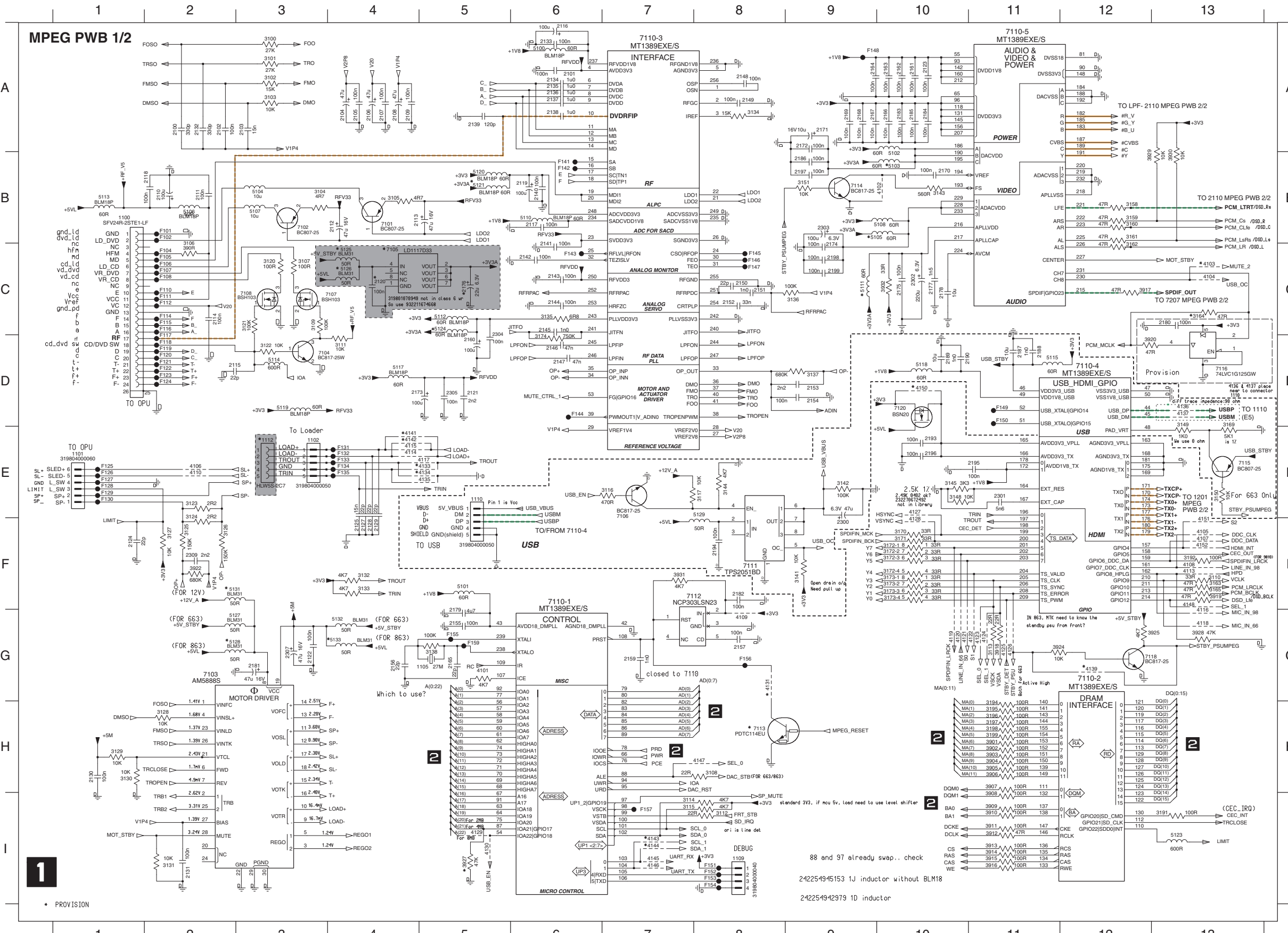

1100 B1	3106 C2	4123 G11	F149 D11
1101 E1	3107 C3	4124 G11	F150 D11
1102 E3	3108 H8	4125 G11	F151 B8
1103 G5	3109 C3	4126 G11	F152 B8
1103 B8	3110 F13	4127 E10	F153 B8
1110 E5	3111 D4	4128 F10	F154 B8
1112 E3	3112 B8	4129 B5	F155 G5
1100 A2	3113 G11	4130 A5	F156 G8
2101 A6	3114 I7	4131 G8	F157 I7
2102 A2	3115 I7	4132 A5	F159 G5
2103 A2	3116 E7	4134 E5	
2104 A4	3117 E8	4135 E5	
2105 A4	3118 B4	4136 D13	
2106 A4	3121 C3	4137 D13	
2107 A4	3122 D3	4139 G12	
2108 A4	3123 E2	4141 E4	
2109 A4	3124 F2	4142 E4	
2110 B2	3125 F2	4143 I7	
2111 B2	3126 F2	4144 I7	
2112 B4	3127 F2	4145 I7	
2113 B4	3128 H2	4146 I7	
2114 C2	3129 H1	4147 H8	
2115 D2	3130 H1	4148 F13	
2116 A6	3131 I2	4150 D10	
2117 B6	3132 F4	4151 F13	
2118 B2	3133 F4	4152 F13	
2119 B6	3134 A8	5100 A6	
2120 C6	3135 C8	5101 F5	
2121 D5	3136 C9	5102 B10	
2122 G3	3137 D9	5103 B10	
2123 A10	3138 G5	5104 B3	
2124 F1	3141 F9	5105 B9	
2125 F4	3142 E9	5106 B2	
2127 F4	3143 B10	5107 B3	
2128 F4	3144 E8	5108 B10	
2129 F4	3145 E10	5110 B6	
2130 H1	3148 E10	5111 C9	
2131 I2	3149 D13	5112 C5	
2132 A2	3150 E13	5113 B1	
2133 A6	3151 B9	5114 D3	
2134 A6	3158 B12	5115 D11	
2135 A6	3159 B12	5117 D4	
2136 A6	3160 B12	5118 D10	
2137 A6	3161 B12	5119 D3	
2138 A6	3162 C12	5120 B5	
2139 A5	3163 F13	5121 B5	
2140 B6	3164 C13	5123 I13	
2141 C6	3165 F13	5124 C5	
2142 C6	3169 D13	5125 C4	
2143 C6	3170 F10	5126 C4	
2144 C6	3171 F10	5127 G2	
2145 C6	3172-1 F10	5128 G2	
2146 D6	3172-2 F10	5129 E8	
2147 D6	3172-3 F10	5131 F2	
2148 D6	3172-4 F10	5132 G4	
2149 A8	3173-1 F10	5133 G4	
2150 C8	3173-2 F10	7101 B4	
2151 C8	3173-3 F10	7102 B3	
2152 C8	3173-4 F10	7103 G2	
2153 D9	3174 D6	7104 D3	
2154 D9	3191 I13	7105 C4	
2155 G5	3192 F13	7106 E7	
2156 G4	3194 H1	7107 C3	
2157 G8	3195 H1	7108 C3	
2158 G7	3196 H1	7110-1 F6	
2160 D5	3197 H1	7110-2 G12	
2161 A10	3198 H1	7110-3 A7	
2162 A10	3199 H1	7110-4 D12	
2163 A10	3201 H1	7110-5 A11	
2164 A9	3202 H1	7111 F8	
2165 G5	3203 H1	7112 F7	
2166 A10	3204 H1	7113 H8	
2167 A9	3205 H1	7114 B9	
2168 A9	3206 H1	7115 E13	
2169 A9	3207 H1	7116 D13	
2170 B10	3208 H1	7118 G12	
2171 A9	3209 H1	7120 D10	
2172 A9	3210 H1	7121 B2	
2173 D4	3211 H1	7122 B2	
2174 C9	3212 H1	7123 C2	
2175 C10	3213 H1	7124 C2	
2176 C5	3214 H1	7125 C2	
2177 C10	3215 H1	7126 C2	
2178 C10	3216 H1	7127 C2	
2179 G5	3217 H1	7128 C2	
2180 C13	3218 H1	7129 H1	
2181 G3	3219 F13	7130 C2	
2182 F8	3220 D12	7131 C2	
2183 A10	3222 F2	7132 C2	
2184 A10	3223 G11	7133 C2	
2185 A10	3225 G13	7134 D2	
2186 B9	3227 I5	7135 D2	
2187 D11	3228 G13	7136 D2	
2188 D11	3229 B13	7137 D2	
2189 D10	3230 B13	7138 D2	
2190 D10	3231 F7	7139 D2	
2193 E10	3232 C10	7140 D2	
2194 F8	4101 G5	7141 D2	
2195 E11	4102 B10	7142 E1	
2196 E10	4103 C13	7143 E1	
2197 B9	4104 C13	7144 E1	
2198 C9	4105 F13	7145 E1	
2199 C9	4106 E2	7146 E1	
2200 F9	4107 C13	7147 E1	
2201 E1	4108 F13	7148 E1	
2202 C10	4109 G8	7149 G8	
2203 B9	4110 E2	7150 G8	
2204 C5	4111 F13	7151 E4	
2205 D5	4114 E4	7152 E4	
2207 G3	4115 E4	7153 E4	
2209 F2	4116 G13	7154 B6	
2210 A3	4117 G5	7155 G5	
2211 A3	4118 G13	7156 G5	
2212 A3	4119 G10	7157 G5	
2213 A3	4120 G10	7158 G5	
2214 B3	4121 G10	7159 G5	
2215 B4	4122 G11	7160 G5	

MPEG PWB 2/2

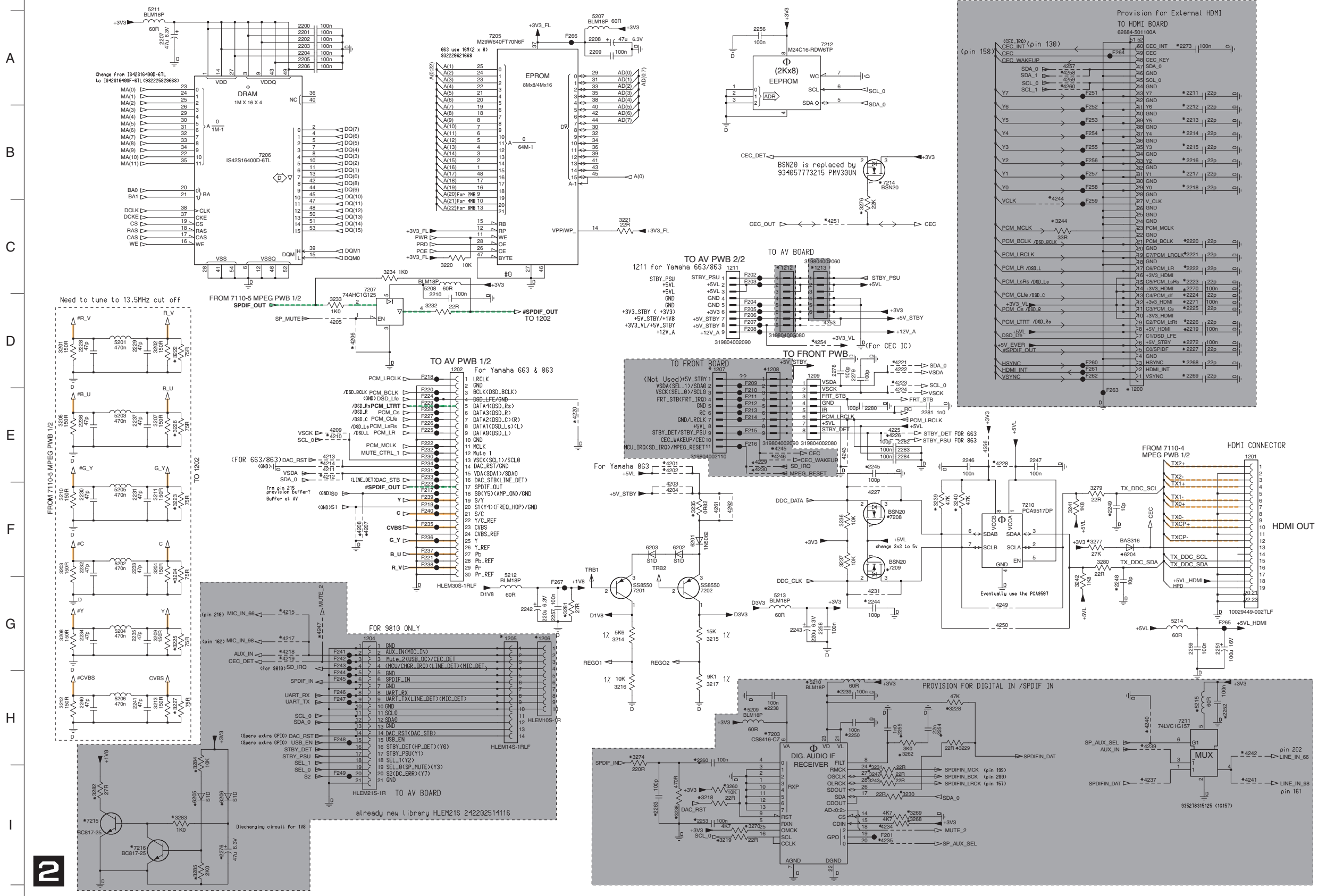

1200 D12	3231 I9	7215 I1
1201 E13	3232 D4	7216 I1
1202 D5	3233 D3	F201 I9
1204 G4	3234 C4	F202 C8
1205 G5	3235 F7	F203 C8
1206 G6	3236 F9	F204 D8
1207 D7	3237 F9	F205 D8
1208 D8	3238 I7	F206 D8
1209 D8	3239 F10	F207 D8
1211 C8	3240 F10	F208 D8
1212 C8	3241 F11	F209 D8
1213 C8	3242 G11	F210 E8
2200 A3	3243 I9	F211 E8
2201 A3	3244 C11	F212 E8
2202 A3	3247 I9	F213 E8
2203 A3	3260 I8	F214 E8
2204 A3	3262 H9	F215 E8
2205 A3	3268 I10	F216 E8
2206 A3	3269 I10	F217 F4
2207 A2	3270 I8	F218 D4
2208 A6	3274 H7	F219 F4
2209 A6	3276 C9	F220 E4
2210 C4	3277 F11	F221 F4
2211 A12	3279 F11	F222 E4
2212 B12	3280 F11	F223 F4
2213 B12	3281 G6	F224 E4
2214 B12	3282 I1	F225 E4
2215 B12	3283 I2	F226 E4
2216 B12	3284 H2	F227 E4
2217 B12	3285 I2	F228 E4
2218 B12	4201 E7	F229 E4
2219 D12	4202 E7	F230 E4
2220 C12	4203 F7	F231 E4
2221 C12	4204 F7	F232 E4
2222 C12	4205 D3	F233 E4
2223 C12	4206 D4	F234 E4
2224 D12	4207 F4	F235 F4
2225 D12	4208 F4	F236 F4
2226 D12	4209 E3	F237 F4
2227 D12	4210 E3	F238 F4
2228 D1	4211 E3	F239 F4
2229 D1	4212 E3	F240 F4
2230 F1	4213 E3	F241 G3
2231 F1	4214 E3	F242 G3
2232 F1	4215 G3	F243 G3
2233 F1	4217 G3	F244 H3
2234 G1	4218 G3	F245 H3
2235 G1	4219 G3	F246 H3
2236 E1	4220 E6	F247 H3
2237 E1	4221 H2	F248 H3
2238 H8	4222 D9	F249 I3
2239 H9	4223 D9	F251 A11
2240 H1	4224 E9	F252 B11
2241 H1	4225 E9	F253 B11
2242 G5	4226 E9	F254 B11
2243 G8	4227 F9	F255 B11
2244 G9	4228 E10	F256 B11
2245 E9	4229 E8	F257 B11
2246 E10	4230 E8	F258 B11
2247 E11	4231 G9	F259 C11
2248 D9	4232 A11	F260 D11
2249 I2	4235 I9	F261 D11
2250 H9	4237 I12	F262 D11
2251 G13	4238 H12	F263 E12
2252 H13	4240 H12	F264 A12
2253 I7	4241 I13	F265 G13
2254 H10	4242 H13	F266 A6
2255 H9	4243 E9	F267 G6
2256 A8	4244 C11	
2257 G6	4245 E8	
2258 G9	4246 E8	
2259 C12	4247 G3	
2260 H7	4249 G10	
2263 I7	4250 G10	
2268 D12	4251 C9	
2269 D12	4253 D9	
2270 C12	4254 D8	
2271 D12	4256 E10	
2272 D12	4257 A11	
2273 A12	4258 A11	
2276 I2	4259 A11	
2278 D9	4260 A11	
2279 D9	4261 F7	
2280 E9	4262 F8	
2281 E10	5201 D1	
2282 E9	5202 F1	
2283 E9	5203 E1	
2284 E9	5204 G1	
3201 D1	5205 F1	
3202 D1	5206 H1	
3203 F1	5207 A6	
3204 F1	5208 C4	
3206 E1	5209 H8	
3207 E1	5210 H9	
3208 G1	5211 A1	
3209 G1	5212 G5	
3210 F1	5213 G8	
3211 F1	5214 G12	
3212 H1	5215 H13	
3213 H1	6201 F7	
3214 G6	6202 F7	
3215 G7	6203 F7	
3216 H6	6204 F12	
3217 H6	6205 I2	
3218 I7	6206 I2	
3219 I7	7201 G7	
3220 C5	7202 G7	
3221 C6	7203 H8	
3222 D2	7205 A5	
3223 F2	7206 B3	
3224 F2	7207 C4	
3225 G2	7208 F9	
3226 E2	7209 F9	
3228 H10	7210 F11	
3229 H10	7211 A12	
3230 I9	7214 B9	

PROVISION



**FRONT DISPLAY PWB**

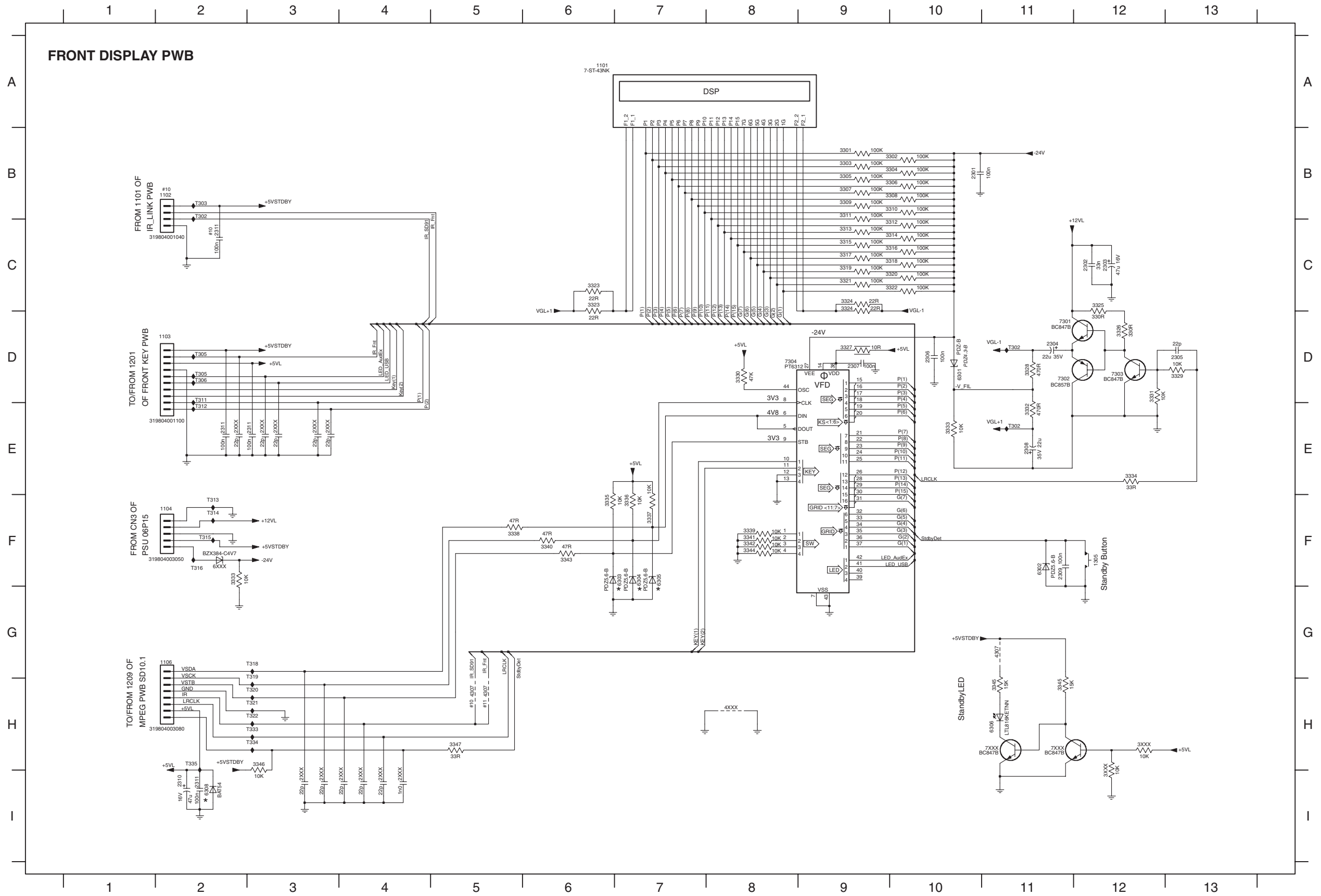

#10 US  
 #11 EU & China  
 \* Optional

- T114 F2
- T115 F2
- T116 F2
- T118 G3
- T119 G3
- T120 H3
- T121 H3
- T122 H3
- T123 H3
- T124 H3
- T125 H2
- T134 D11
- T135 E11
- T110 A6
- T110 B2
- T110 C2
- T110 G2
- T110 H10
- T110 H11
- T110 I2
- T111 I2
- T112 C2
- T116 E2
- T117 E3
- T118 E3
- T119 E3
- T122 E3
- T123 E3
- T124 I3
- T125 I3
- T126 I4
- T127 I4
- T128 I4
- T129 I4
- T101 B9
- T102 B10
- T103 B9
- T104 B10
- T105 B9
- T106 B10
- T107 B9
- T108 B10
- T109 B9
- T110 B10
- T111 B9
- T112 C10
- T113 C9
- T114 C10
- T115 C9
- T116 C10
- T117 C9
- T118 C10
- T119 C9
- T120 C10
- T121 C9
- T122 C10
- T123 C6
- T124 C9
- T125 C12
- T126 D12
- T127 D9
- T128 D11
- T129 D13
- T130 D8
- T131 D12
- T132 E11
- T133 E10
- T134 E12
- T135 F6
- T136 F7
- T137 F7
- T138 F5
- T139 F8
- T140 F6
- T141 F8
- T142 F8
- T143 F6
- T144 F8
- T145 H11
- T146 H3
- T147 H5
- T148 H11
- T149 H12
- T150 H12
- T151 C6
- T152 C9
- T153 F2
- T154 H5
- T155 H5
- T156 H8
- T157 G11
- T158 D10
- T159 F11
- T160 F7
- T161 F7
- T162 F7
- T163 H2
- T164 H11
- T165 H11
- T166 H11
- T167 B2
- T168 D2
- T169 D2
- T170 D2
- T171 D2
- T172 E2
- T173 F2

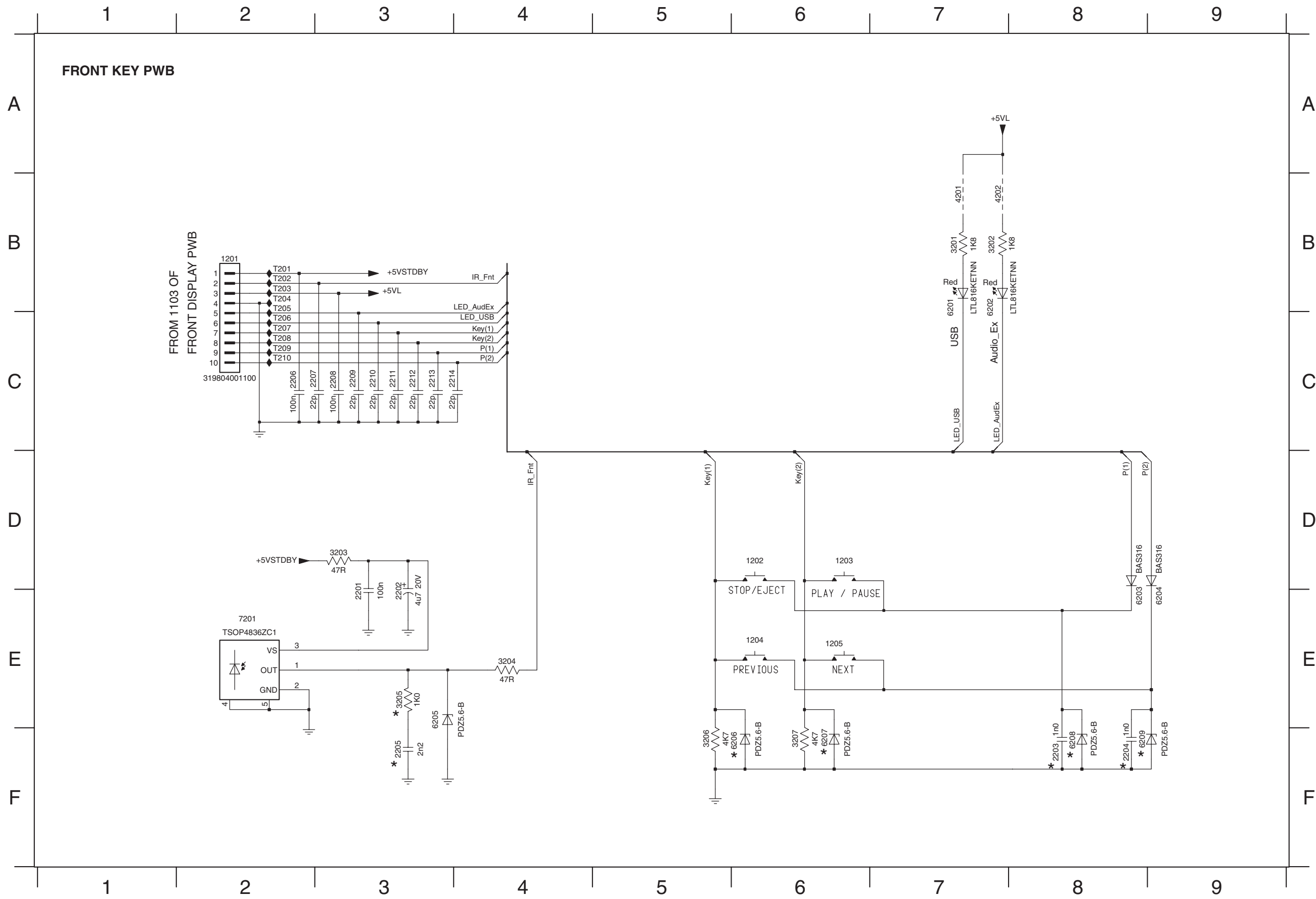

- 1201 B2
- 1202 D6
- 1203 D6
- 1204 E6
- 1205 E6
- 2201 E3
- 2202 E3
- 2203 F8
- 2204 F8
- 2205 F3
- 2206 C2
- 2207 C3
- 2208 C3
- 2209 C3
- 2210 C3
- 2211 C3
- 2212 C3
- 2213 C3
- 2214 C4
- 3201 B7
- 3202 B7
- 3203 D3
- 3204 E4
- 3205 E3
- 3206 F5
- 3207 F6
- 4201 B7
- 4202 B7
- 6201 B7
- 6202 B7
- 6203 E8
- 6204 E9
- 6205 E3
- 6206 F6
- 6207 F6
- 6208 F8
- 6209 F8
- 7201 E2
- T201 B2
- T202 B2
- T203 B2
- T204 B2
- T205 B2
- T206 C2
- T207 C2
- T208 C2
- T209 C2
- T210 C2

1101 A1	1104 A4	2103 A2	2106 D1	3102 D2	3105 B2	7102 D3	I101 A1	I104 A1
1102 B1	2101 B2	2104 A2	2107 D1	3103 D2	6101 C3	7103 D2	I102 A1	I105 B2
1103 D1	2102 A1	2105 A2	3101 D1	3104 B4	7101 D4	7104 B4	I103 A1	I106 D1

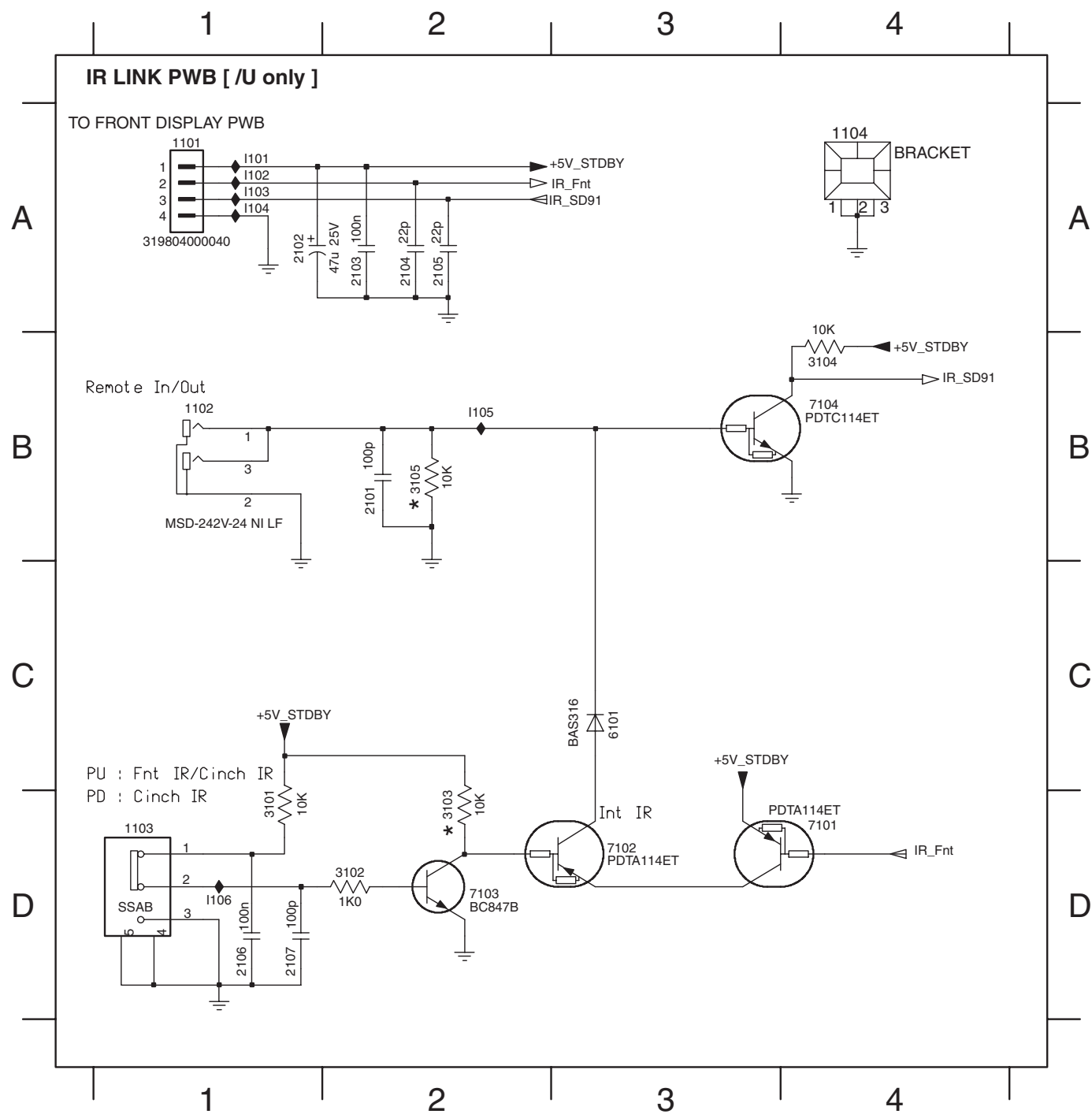

PSU PWB

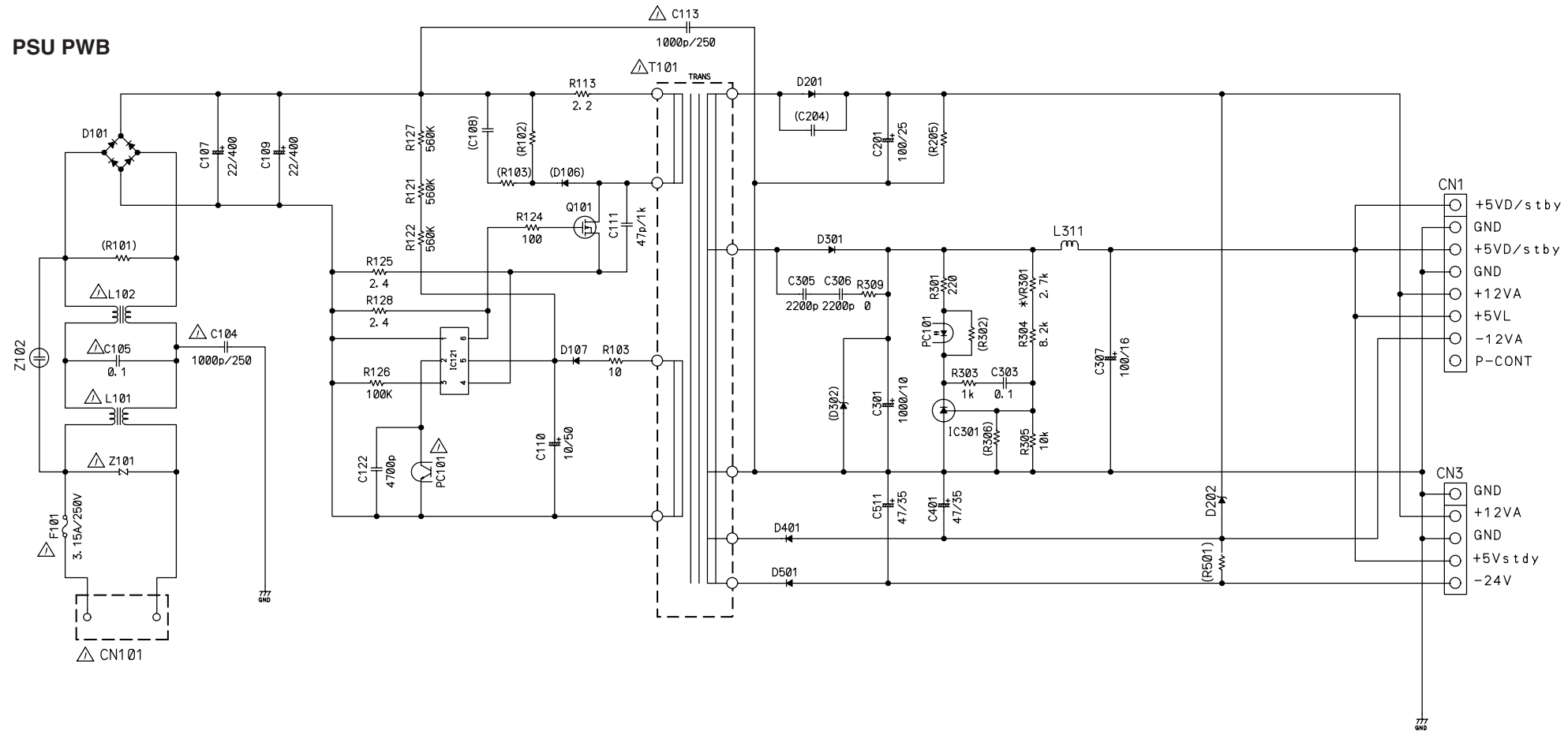

D101	D1UBA80	D201, D401	PR1003, RGP10D
D107	PR1003, RGP10D	D202	MTZ30, MA4300
IC121	SG6848	D301	SB560, RK46
Q101	FQI2N80	D501	PR1005, RGP10J
PC101	LTV-817M, PC123, PS2561	IC301	TL431, MM1431A

# 11. PARTS LOCATION

## PSU A PWB

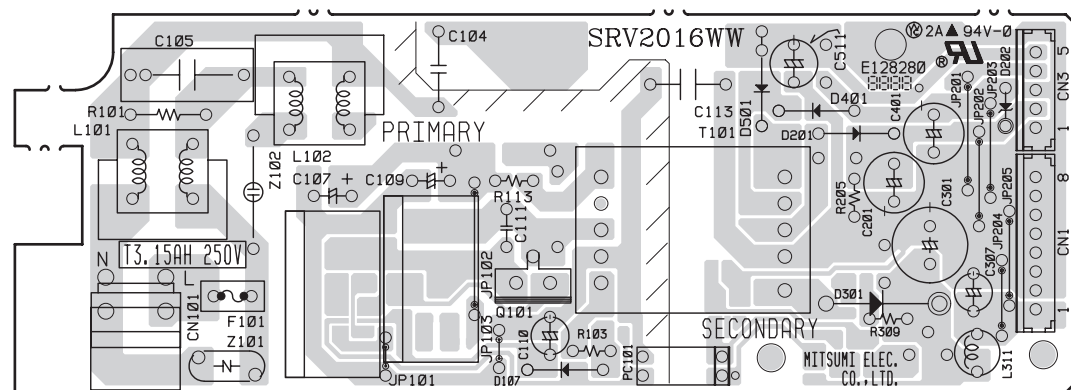

## PSU B PWB

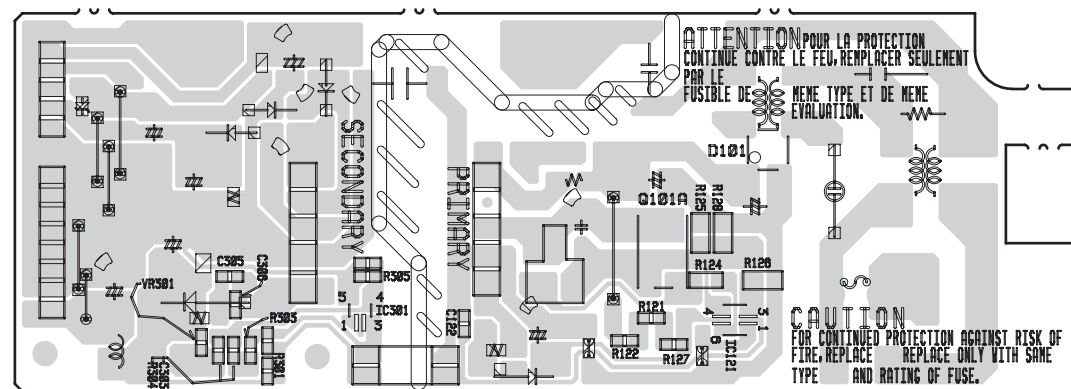

## IR LINK A PWB [ /U only ]

1101 B2    1103 A2    2102 A2  
1102 A3    1104 A1

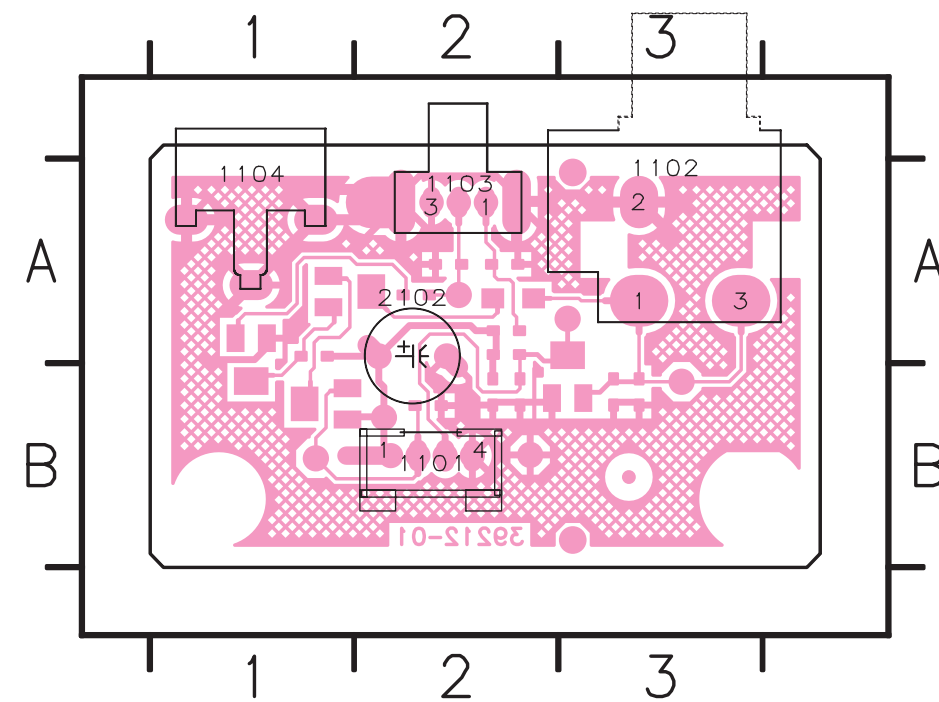

## IR LINK B PWB [ /U only ]

2101 B1    2106 A2    3103 A3    7101 B3  
2103 B2    2107 A2    3104 A2    7102 A3  
2104 B2    3101 A2    3105 B1    7103 A3  
2105 B2    3102 A2    6101 A2    7104 B1

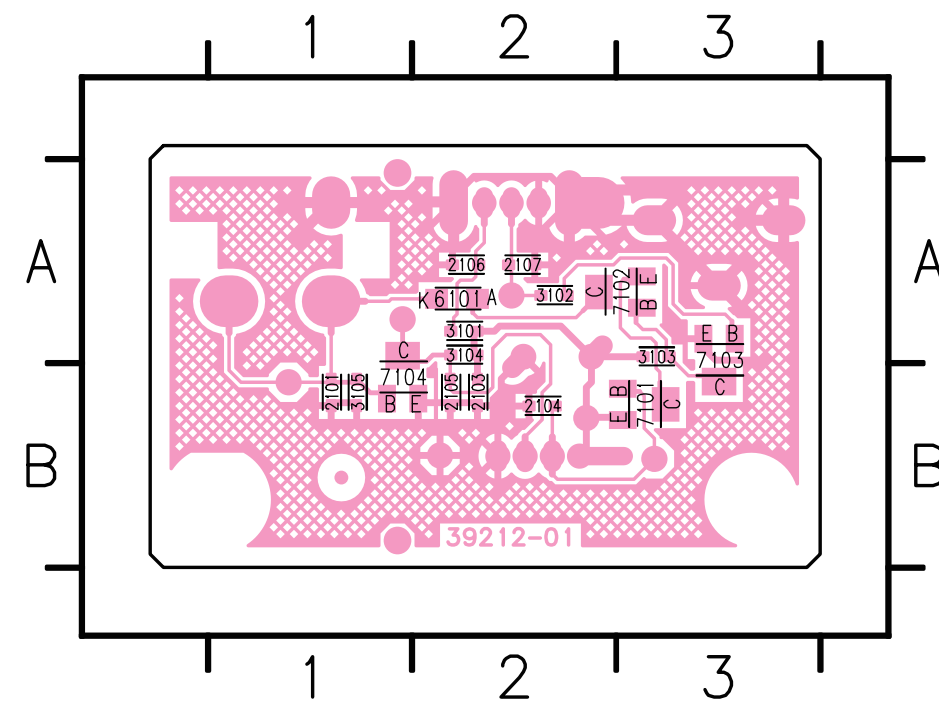

**鉛フリー半田**  
半田付けには、鉛フリー半田 (Sn-Ag-Cu) を使用してください。  
**Lead-free Solder**  
When soldering, use the Lead-free Solder (Sn-Ag-Cu).













**FRONT DISPLAY A PWB**

1101	A5	1105	A2	2108	A2	2119	A4	3132	A2	3138	A3	3147	A2	6104	A3
1102	A4	1106	A1	2110	A1	2122	A6	3135	A3	3140	A3	4101	A4	6105	A3
1103	A5	2103	A1	2112	A4	2126	A2	3136	A3	3143	A3	4102	A3	6106	A2
1104	A1	2104	A2	2118	A4	3128	A2	3137	A3	3146	A2	6103	A3		

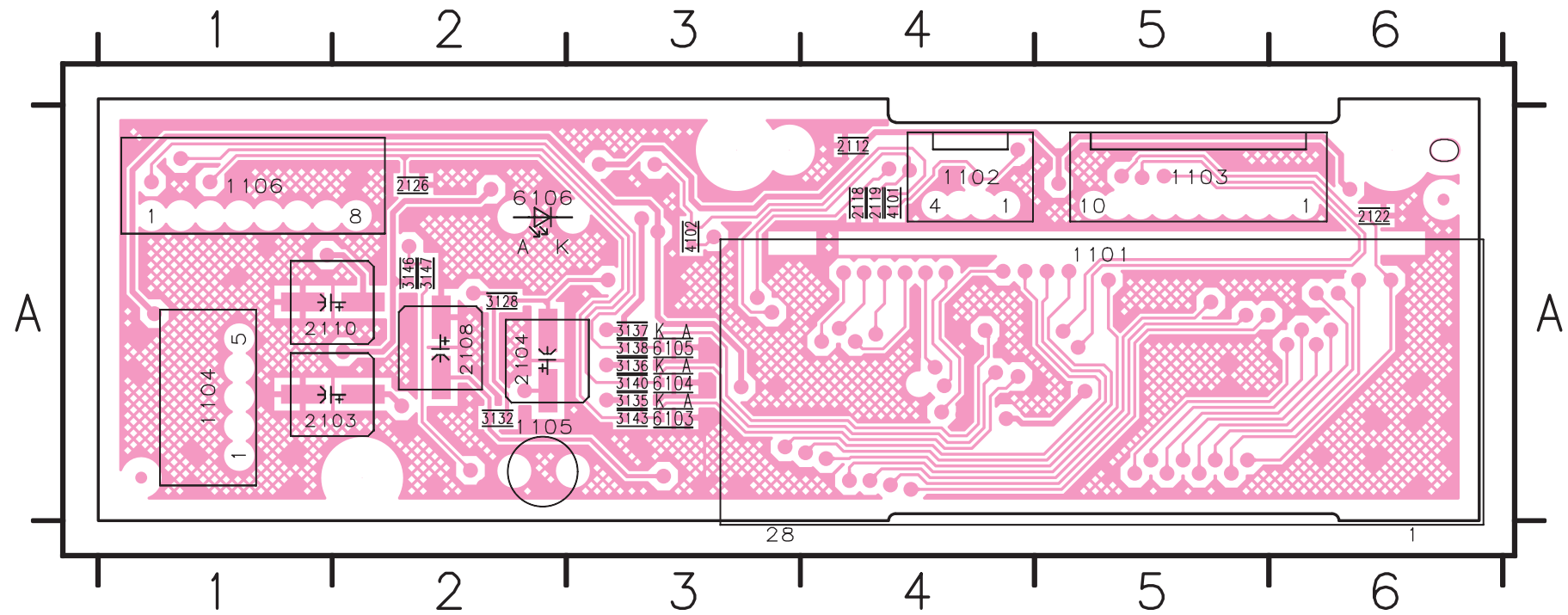

**FRONT DISPLAY B PWB**

1107	A6	2115	A1	2129	A5	3108	A1	3116	A4	3124	A4	3134	A5	3150	A5	6107	A6
2101	A1	2116	A1	3101	A1	3109	A2	3117	A4	3125	A5	3139	A2	3151	A1	6108	A5
2102	A6	2117	A2	3102	A1	3110	A2	3118	A4	3126	A5	3141	A2	3152	A4	7101	A5
2105	A5	2123	A2	3103	A1	3111	A2	3119	A3	3127	A4	3142	A2	3153	A6	7102	A5
2106	A4	2124	A6	3104	A1	3112	A2	3120	A3	3129	A5	3144	A2	4103	A6	7103	A5
2107	A4	2125	A6	3105	A1	3113	A2	3121	A3	3130	A4	3145	A5	4107	A5	7104	A3
2109	A5	2127	A6	3106	A1	3114	A2	3122	A4	3131	A5	3148	A5	6101	A6	7105	A5
2111	A5	2128	A6	3107	A1	3115	A2	3123	A1	3133	A5	3149	A5	6102	A5	7106	A5

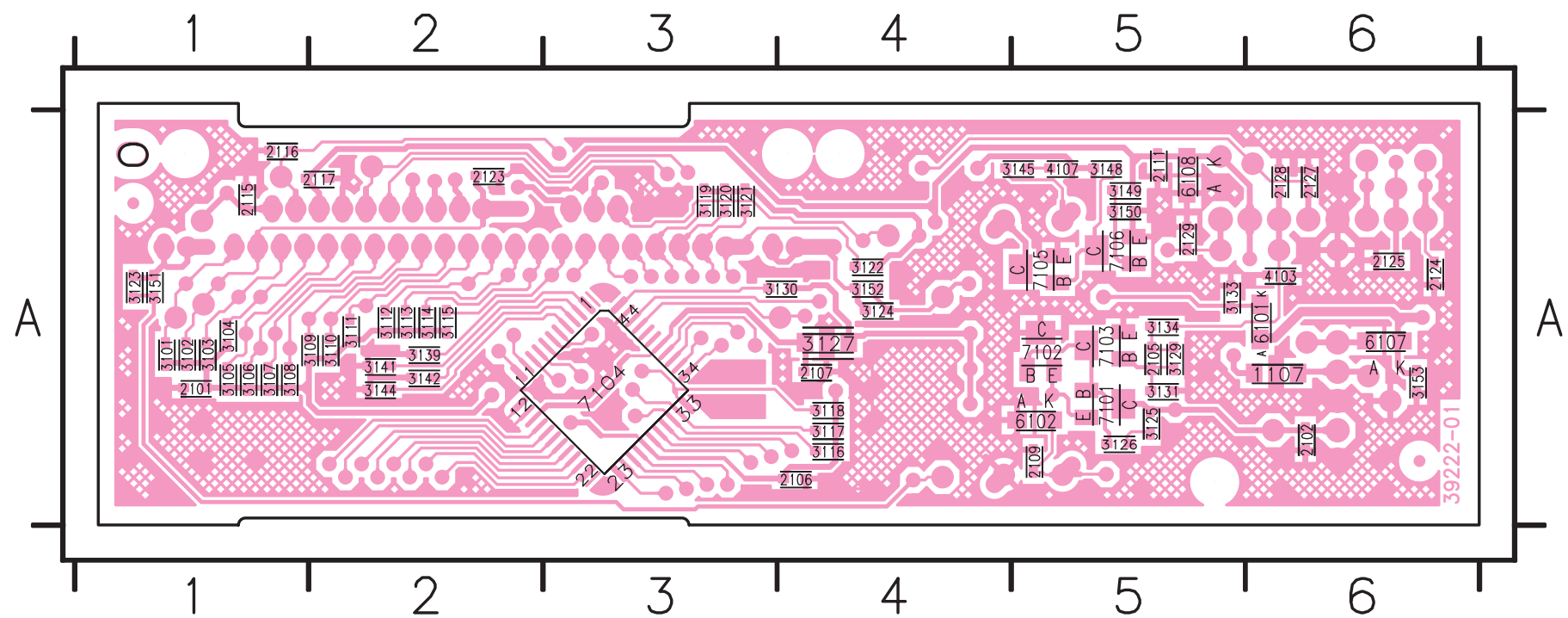

**鉛フリー半田**  
半田付けには、鉛フリー半田 (Sn-Ag-Cu) を使用してください。

**Lead-free Solder**  
When soldering, use the Lead-free Solder (Sn-Ag-Cu).

**FRONT KEY A PWB**

1201 A5 1202 A1 1203 A2 1204 A2 1205 A3 6201 A2 6202 A1 7201 A1

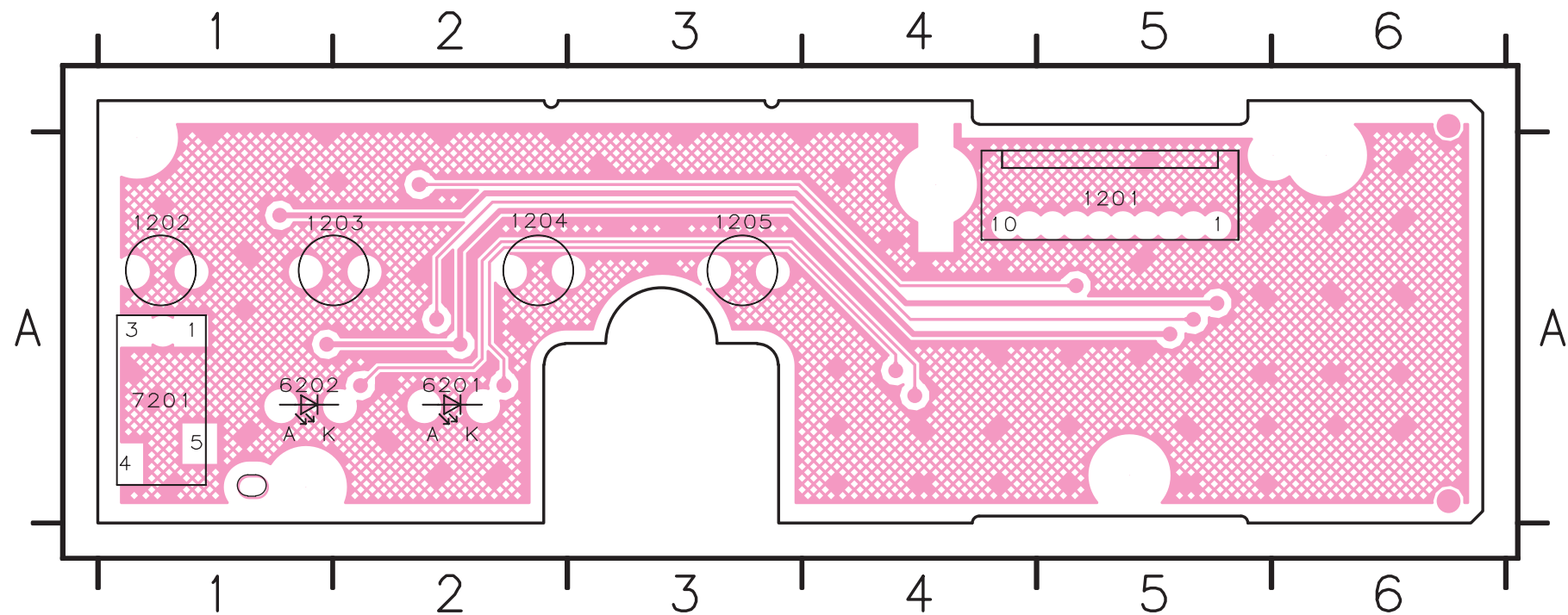

**FRONT KEY B PWB**

2201 A6 2205 A6 2209 A2 2213 A3 3203 A6 3207 A3 6204 A4 6208 A5  
 2202 A6 2206 A2 2210 A2 2214 A3 3204 A6 4201 A5 6205 A6 6209 A4  
 2203 A5 2207 A2 2211 A2 3201 A5 3205 A6 4202 A6 6206 A5  
 2204 A4 2208 A2 2212 A2 3202 A6 3206 A5 6203 A5 6207 A3

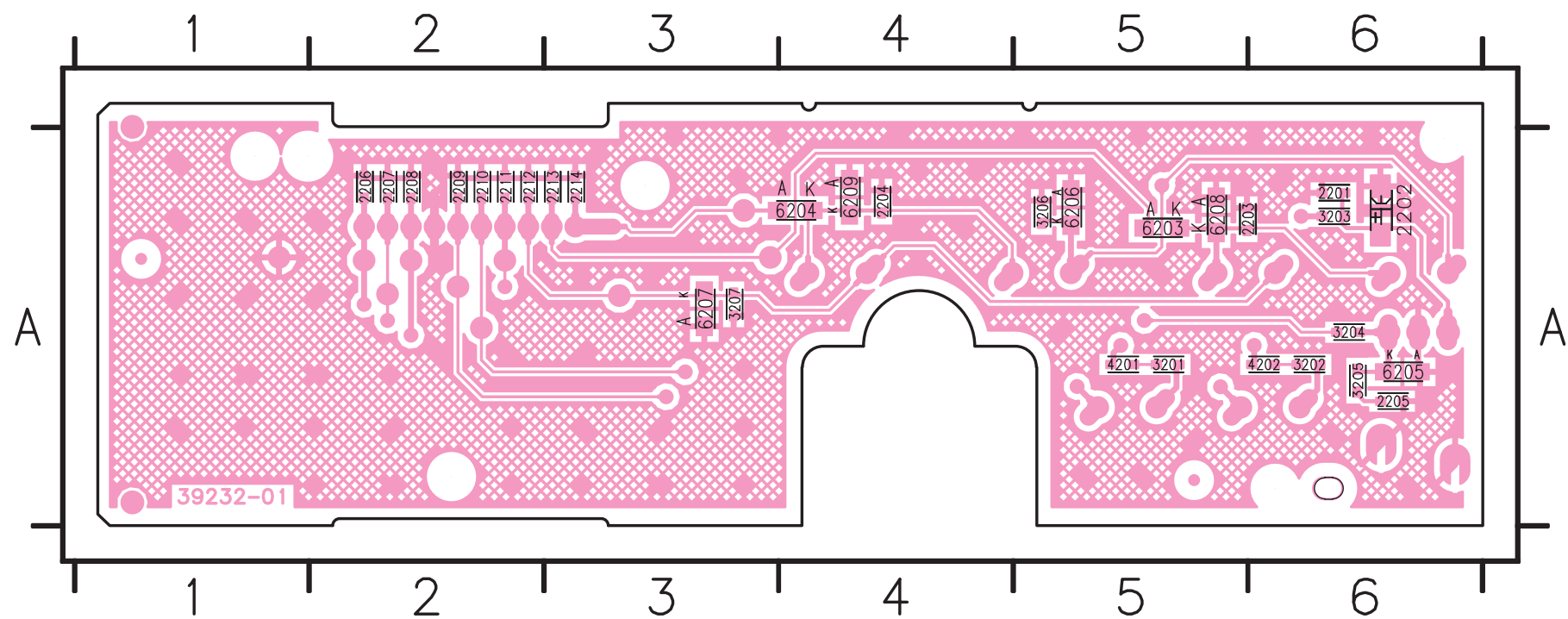

**鉛フリー半田**  
 半田付けには、鉛フリー半田 (Sn-Ag-Cu) を使用してください。  
**Lead-free Solder**  
 When soldering, use the Lead-free Solder (Sn-Ag-Cu).





P.W.B. NAME	POS. NO.	VERS. COLOR	PART NO. (FOR EUR)	PART NO. (MZ)	PART NAME	DESCRIPTION	
	P001	/K1SG	nsp	975402000020M	PANEL	CAB FRONT ASSY DV4003SG	314107946221
	P001	/N1B	975402000010M	975402000010M	PANEL	CAB FRONT ASSY DV4003B	314107946211
	P001	/N1SG	975402000020M	975402000020M	PANEL	CAB FRONT ASSY DV4003SG	314107946221
	P001	/U1B	nsp	975402000010M	PANEL	CAB FRONT ASSY DV4003B	314107946211
	P002		975441000030M	975441000030M	CHASSIS	FRAME ASSY DV4003	314107946231
	0110		975418000040M	975418000040M	ESCUTCHEON	COVER TRAY MDVS4003	313924419561
	0181		nsp	nsp	BRACKET	BRACKET LOADER MDVS4001	313924413651
	0200		nsp	nsp	SPRING	SPRING USB MDVS4003	313924128571
	0201		nsp	nsp	SPRING	ESD SPRING MDVS4001	313924126131
	0202		nsp	nsp	SPRING	ESD SPRING MDVS4001	313924126131
	0203		nsp	nsp	SPRING	SPRING GROUNDING	313911101471
	0204		nsp	nsp	SHEET	CUTSHEET DISPLAY DV4003	313924419661
	0205		nsp	nsp	SHEET	CUTSHEET KEY DV4003	313924419671
	0230	/K1SG	nsp	nsp	PLATE	PLATE REAR MDVS4003/93	313924128551
	0230	/N1B	nsp	nsp	PLATE	PLATE REAR MDVS4003/12	313924128531
	0230	/N1SG	nsp	nsp	PLATE	PLATE REAR MDVS4003/12	313924128531
	0230	/U1B	nsp	nsp	PLATE	PLATE REAR MDVS4003/37	313924128541
	1001	/K1SG	nsp	975309000080M	PWB ASSY	PCBAS FRONT PANEL DV4003	313924854531
	1001	/N1B	975309000080M	975309000080M	PWB ASSY	PCBAS FRONT PANEL DV4003	313924854531
	1001	/N1SG	975309000080M	975309000080M	PWB ASSY	PCBAS FRONT PANEL DV4003	313924854531
	1001	/U1B	nsp	975309000090M	PWB ASSY	PCBAS FRONT PANEL DV4003 US	313924854551
	1002	/U1B	nsp	975309000100M	PWB ASSY	PCBAS IR_LINK DV4003	313924854541
	1003	/K1SG	nsp	975309000120M	PWB ASSY	PCBAS MPEG SD10.1 DV4003 AP	313924854581
	1003	/N1B	975309000110M	975309000110M	PWB ASSY	PCBAS MPEG SD10.1 DV4003	313924854571
	1003	/N1SG	975309000110M	975309000110M	PWB ASSY	PCBAS MPEG SD10.1 DV4003	313924854571
	1003	/U1B	nsp	975309000110M	PWB ASSY	PCBAS MPEG SD10.1 DV4003	313924854571
	1004	/K1SG	nsp	975309000140M	PWB ASSY	PCBAS AV DV4003 NON-EU	313924854601
	1004	/N1B	975309000130M	975309000130M	PWB ASSY	PCBAS AV DV4003 EU	313924854591
	1004	/N1SG	975309000130M	975309000130M	PWB ASSY	PCBAS AV DV4003 EU	313924854591
	1004	/U1B	nsp	975309000140M	PWB ASSY	PCBAS AV DV4003 NON-EU	313924854601
	1005		90M-ZZ003810R	90M-ZZ003810R	PWB ASSY	PSU DV4001 06P15 WR SRV2016WW	313924713351
	1006		975304000150M	975304000150M	MECHANISM	LOADER ASSY WXD-8829C YAMAHA	313924714231
	8100		nsp	90M-YU002470R	FPC	FFC FOIL 30P/060/30P AD	313924102491
	8101		nsp	nsp	CORD	CBLE HR 9P/100/9P HR WH UL	310431102621
	8102		nsp	nsp	CORD	CBLE HR 8P/280/8P HR WH UL.	310431100411
	8103		nsp	nsp	CORD	CBLE KR 10P/340/10P KR WH UL	310431106691
	8104		975613000160M	975613000160M	CORD	CBLE USB-A 0M3 PH 5P BK B	242207600786
	8105	/U1B	nsp	nsp	CORD	CBLE KR 4P/340/4P KR WH UL	310431107371
	8106	/N1B	nsp	nsp	CORD	CBLE HR 8P/560/8P HR WH UL	310431114171
	8107	/N1B	nsp	nsp	CORD	CBLE HR 5P/220/5P HR WH UL	310431100861
	▲8108	/K1SG	nsp	90M-YT005160R	TERMINAL	# CBLE MAINS ASSY 140MM EU	313924103121
	▲8108	/N1B	90M-YT005160R	90M-YT005160R	TERMINAL	# CBLE MAINS ASSY 140MM EU	313924103121
	▲8108	/N1SG	90M-YT005160R	90M-YT005160R	TERMINAL	# CBLE MAINS ASSY 140MM EU	313924103121
	▲8109	/U1B	nsp	90M-YT005170R	TERMINAL	# CBLE MAINS ASSY 140MM	313924101731
<b>PACKING</b>							
	0341		00MZK20CW0010	00MZK20CW0010	UNIT KIT	REMOTE CONTROLLER RC-001DV	242254901284
	▲0345	/K1SG	nsp	90M-ZC000680R	MAINS CORD	# MAINSCORD CHN 2A5 1M5 DET 2P B	242207098257
	▲0345	/N1B	90M-ZC000610R	90M-ZC000610R	MAINS CORD	# MAINSCORD EUR 2A5 1M5 DET 2P B	242207098151
	▲0345	/N1SG	90M-ZC000610R	90M-ZC000610R	MAINS CORD	# MAINSCORD EUR 2A5 1M5 DET 2P B	242207098151
	▲0345	/U1B	nsp	90M-ZC000620R	MAINS CORD	# MAINSCORD UL 7A 1M5 DET 2P B	242207000106
	0350	/N1B	nsp	90M-ZD000610R	CONN. CORD	CBLE CINCH 1M5 CINCH R DYEWB H	242207600718
	0353	/U1B	nsp	90M-ZD000620R	CONN. CORD	CBLE CINCH 1M5 CINCH 1P OG B	242207600855
	0360	/K1SG	nsp	541110153050M	USER GUIDE	USER MANUAL MDVS4003SG/93	313924531321
	0360	/N1B	541110153036M	541110153036M	USER GUIDE	USER MANUAL MDVS4003B/12	313924531311
	0360	/N1SG	541110153036M	541110153036M	USER GUIDE	USER MANUAL MDVS4003B/12	313924531311
	0360	/U1B	nsp	541110153029M	USER GUIDE	USER MANUAL MDVS4003B/37	313924531301
<b>NOT STANDARD SPARE PART</b>							
	0650		nsp	531210046000M	PACKING CASE	BOX DISPLAY MDVS4003B/12	313924632071
	0652		nsp	nsp	PARTITIONER	PLATE CARTON 117 X 249	313924628311
	0662		nsp	975533000060M	CUSHION	BUFFER LEFT MDVS4003	313924632031
	0663		nsp	975533000070M	CUSHION	BUFFER RIGHT MDVS4003	313924632041
	0240	/K1SG	nsp	975403000050M	LID	COVER TOP MDVS4003 SG	313924128561
	0240	/N1B	nsp	00M20CW257010	LID	COVER TOP MDVS4001 BL	313924125291
	0240	/N1SG	nsp	975403000050M	LID	COVER TOP MDVS4003 SG	313924128561
	0240	/U1B	nsp	00M20CW257010	LID	COVER TOP MDVS4001 BL	313924125291

NOTE : \*nsp\* PART IS LISTED FOR REFERENCE ONLY, MARANTZ WILL NOT SUPPLY THESE PARTS.